

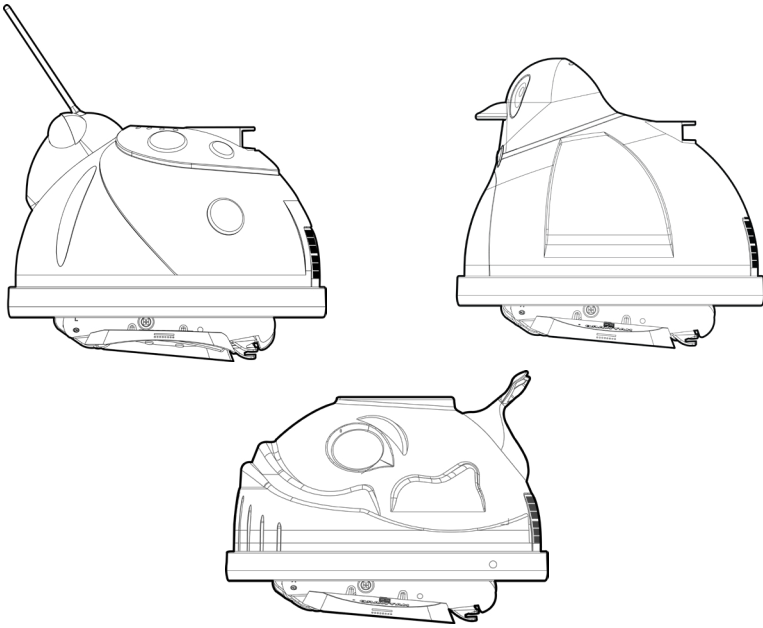

ABOVE GROUND SERIES

Suction Pool Cleaner Owner's Manual



TURBINE SUCTION CLEANER

Owner's Manual

Congratulations on the purchase of your Hayward automatic suction pool cleaning system. Your cleaner is the smart, efficient way to clean your above-ground pool.

Hayward turbine cleaners are powered by your pool's filter system and are designed to work well with most systems. The performance of the cleaner in your pool will be relative to its power source. Because the operation and performance of the cleaner are system reliant, there is a remote possibility that a service call may be necessary to complete the proper installation of your cleaner. This call will be at the consumer's expense.

Lastly, one or more of the accessories designed for the cleaner, including additional hose sections, might be applicable to your installation. Consult your Hayward dealer for prices and availability.

SAFETY WARNINGS

DO NOT use to remove large debris in new pools.

REMOVE cleaner and hose before adding ANY chemicals to your pool.

DO NOT swim with cleaner.

Store the cleaner in a shaded, safe area.

Hoses must be stored straight. **DO NOT** coil the hose.

KEEP AWAY from children and pets.

REMOVE cleaner when performing backwash.

REMEMBER safety first.

For complete warnings and safety information visit www.hayward.com.

KEY



Tip



Pressure Adjustment



Attention



Pump



CARTON CONTENTS

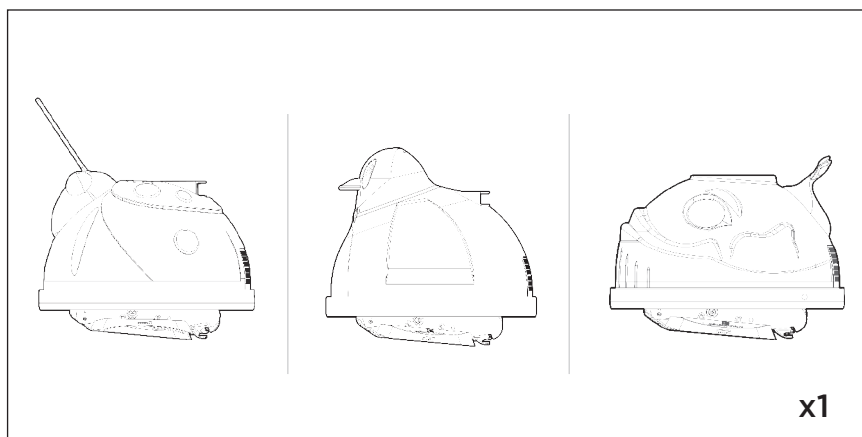

Pool Cleaner

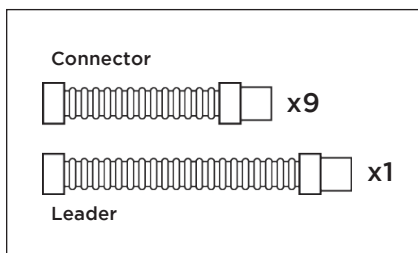

Connector/Leader Hoses

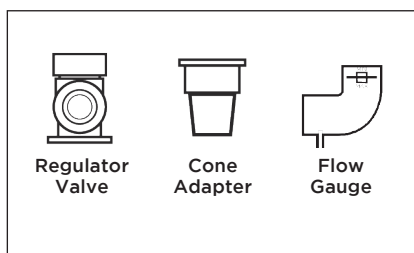

Accessory Kit

PREPARING THE POOL

Please complete the following steps to prepare your pool for installation:

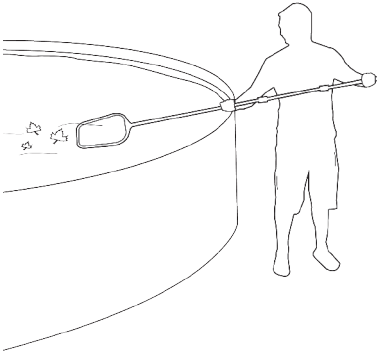

DEBRIS

Remove any large objects and excessive debris from the pool.

WATER LEVEL

Confirm that water level is at the recommended level.

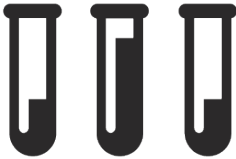

pH: 7.2 - 7.8
Chlorine: 1.0-3.0 PPM
Total Alkalinity: 80 - 120 PPM

WATER CHEMISTRY

Make sure water is properly balanced and that the pool is free from algae.

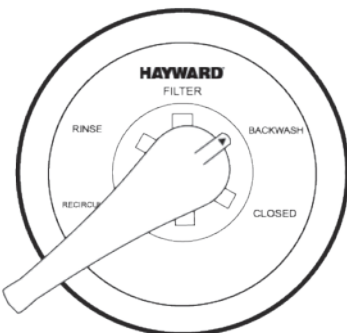

FILTER

Clean or backwash the filter.

Clean the skimmer and pump baskets prior to installing the cleaner.

INSTALLATION

Sizing Suction Hose

Step 1

Connect hose sections.

Note: Make sure all connections are tight to prevent air leaks.

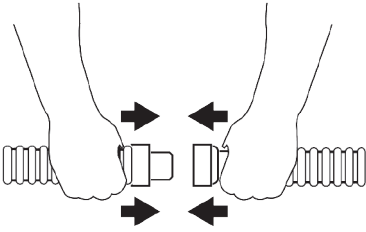

TIP: *Wetting the hose ends will make it easier to connect the hose sections.*



If optional leaf canister is purchased, install between 1st and 2nd hose sections starting from the wall connector or skimmer.

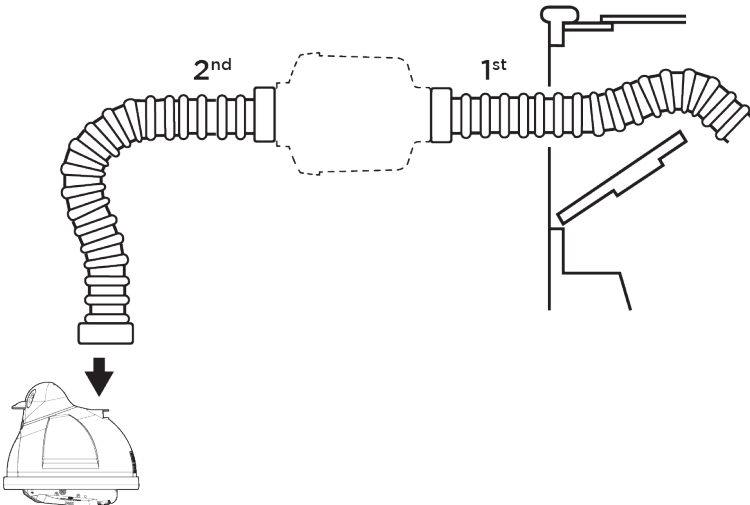

Step 2

Pull hose to farthest location in the pool opposite the wall connector or skimmer **+ 2 extra hose sections**. Extra connector hoses may be required (sold separately).

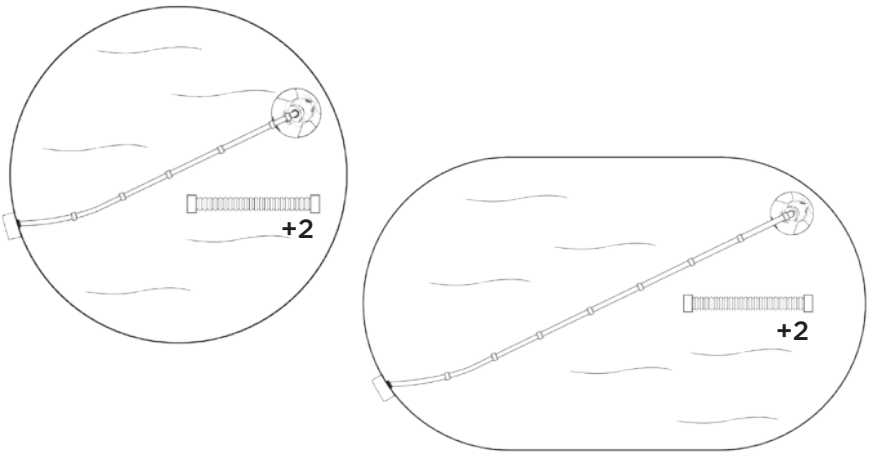

Step 3



Fill hose completely with water.
Insert flow gauge onto the leader hose. Attach the C-clip of the gauge onto the 1st hose section.

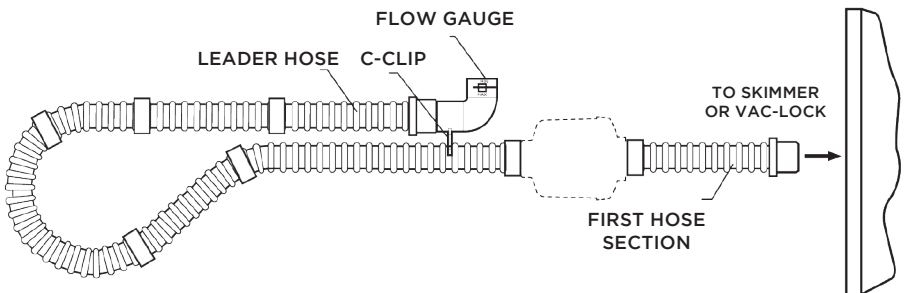

 Make sure the flow gauge is under water.

INSTALLATION

Step 4

Connecting to skimmer:

Connect the skimmer cone adapter to tapered male end of the first hose section.

Note: Hose end goes into cone adapter.

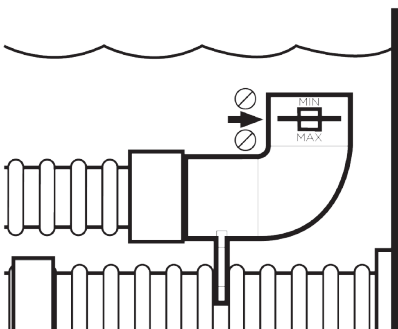
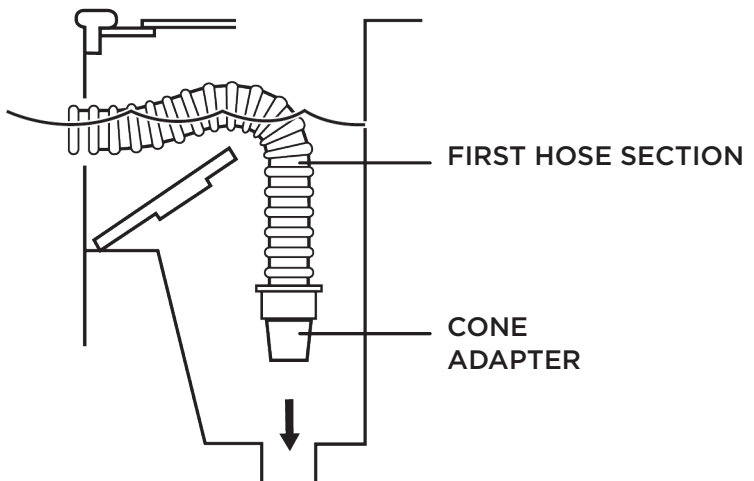

Step 5

Check the water flow reading on the flow gauge.

The black disk should be between the "MIN" and "MAX" markings.

If the disk is in the proper location, move on to step 6.

Reading Too High?

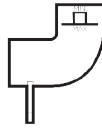

If the black disk is outside of the box on the “MAX” side and you have connected your hose to the skimmer, reduce the vacuum/ water flow by using one of the following:

- Suction valve(s) in the filter system (if equipped with)
- Hayward regulator valve

To install the Hayward regulator valve:



1. Remove the hose from the skimmer cone adapter.
2. Close the regulator valve by rotating the blue collar clockwise until tight.
3. Insert the regulator valve onto the skimmer cone adapter and the hose end into the regulator valve.
4. Turn the filter system on and allow it to evacuate any air in the system.
5. Turn the blue collar clockwise until black disk appears between “MIN” and “MAX” markings.

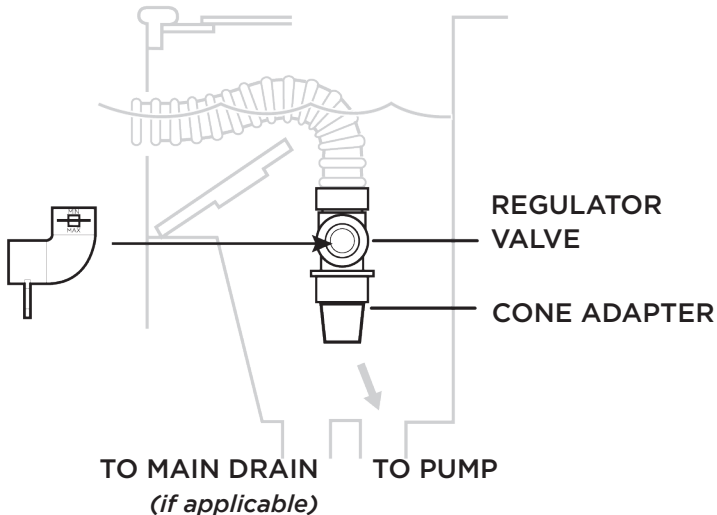

INSTALLATION

Reading Too Low?

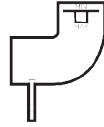

An initial vacuum reading that is TOO low to meet the water flow setting necessary to operate the cleaner is indicative of a system problem, and not a problem with the cleaner.

The regulator valve cannot be used to INCREASE the initial vacuum reading.

Step 6

Submerge the cleaner into the water to remove all air.

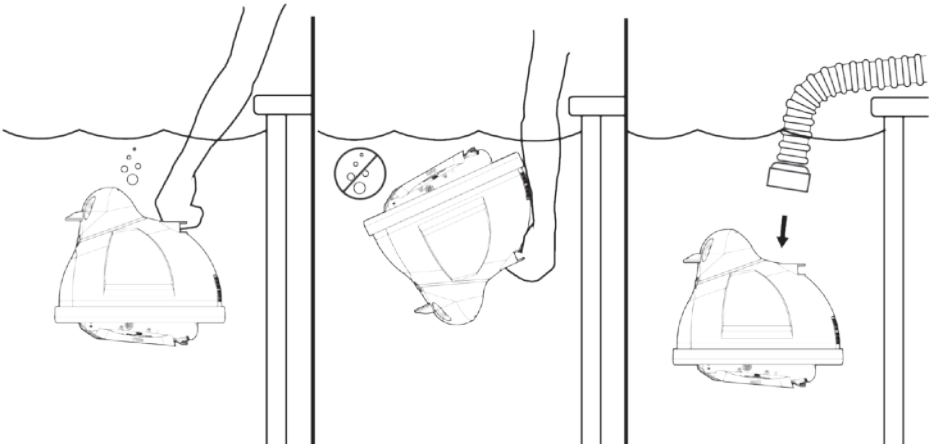



Step 7

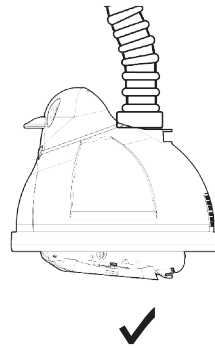
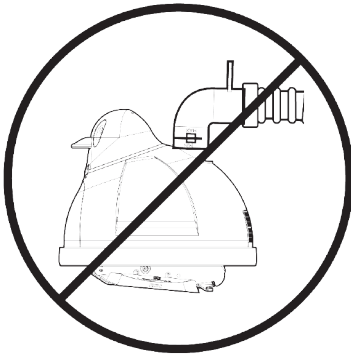
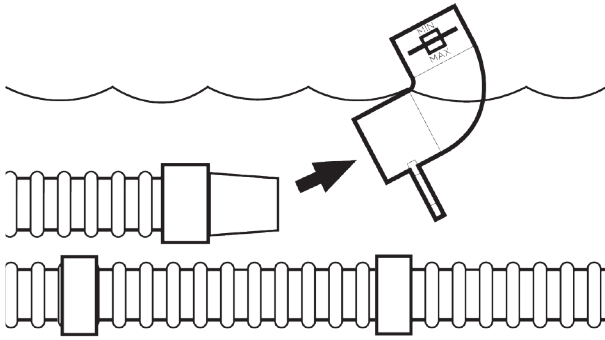

Step 8



Turn pump on and observe cleaner.

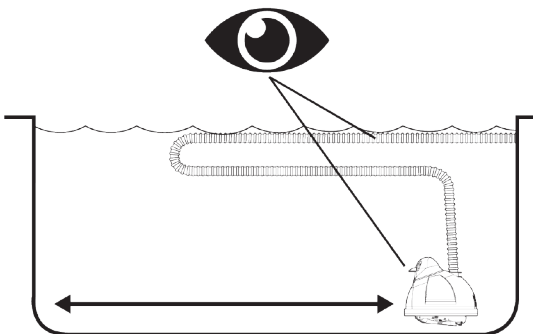



IMPORTANT TIPS

 Periodically check the water flow/vacuum to be sure that your cleaner is operating as efficiently as possible.

Remember, too much vacuum is just as bad as too little.

 Periodically check to make sure that the cleaner hose is securely attached to its suction source (i.e. skimmer, wall connector, etc.).

 Disconnect the cleaner hose from the suction source prior to “backwashing”, to prevent water flow restriction.

 **DO NOT COIL HOSE**
When storing your cleaner, the hose sections must be stored straight. A coiled hose will create a memory in the hose that will impede the cleaner’s ability to move properly.

 **Coiled hoses are not covered under the Hayward warranty.**



 **Adjust the water return toward the center of the pool so water circulation does not interfere with the cleaner’s pool coverage capability.**

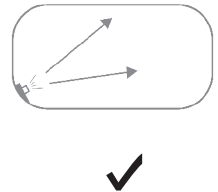
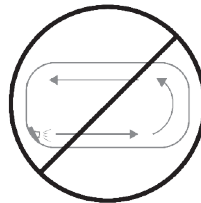
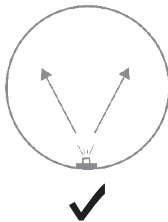
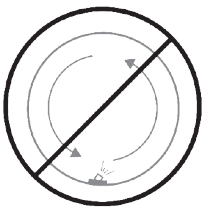

 **Use only original Hayward spare parts and hoses to ensure proper operation.**



When the cleaner is out of the pool, always disconnect the leader hose from the cleaner.

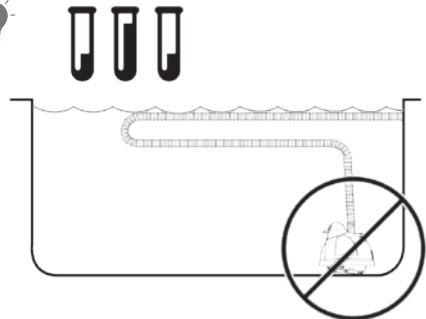

MAINTENANCE TIPS

Check the condition of the “shoes, wings, and flaps” periodically.

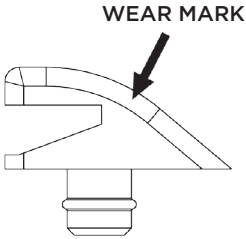

GOOD SHOE

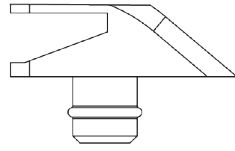

WORN SHOE

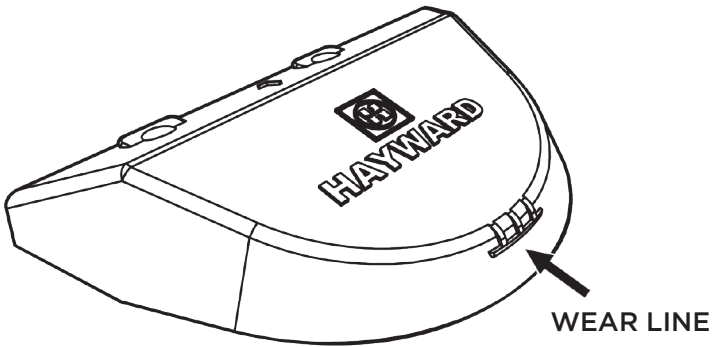

Hayward is not responsible for damage caused by misuse of the cleaner or damage caused by worn or broken parts.

Shoe Replacement:

Step 1

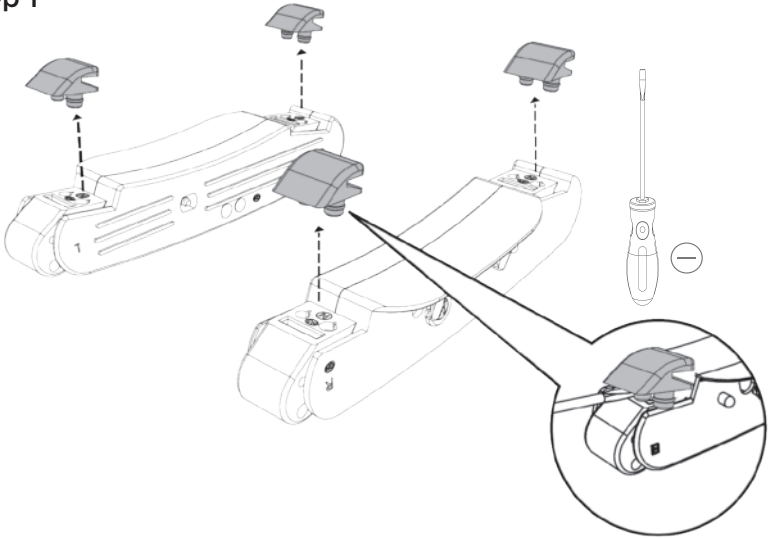

Step 2

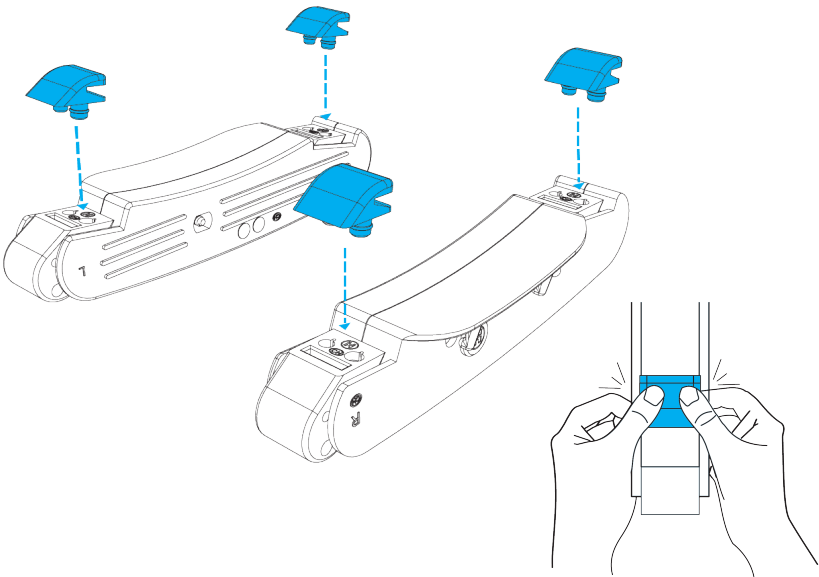

MAINTENANCE TIPS

Wing Replacement:

Step 1

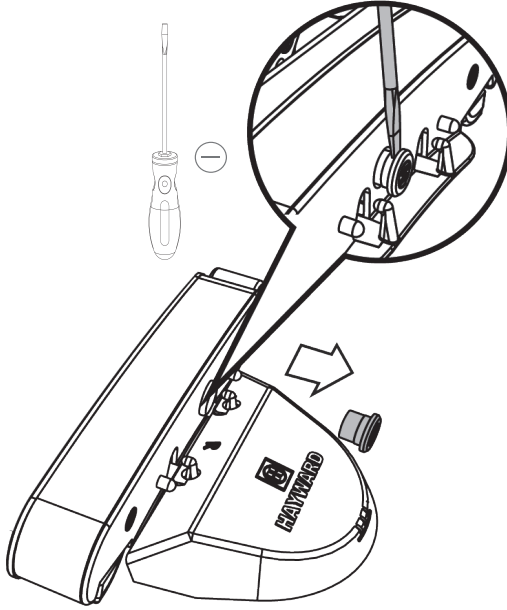

Step 2

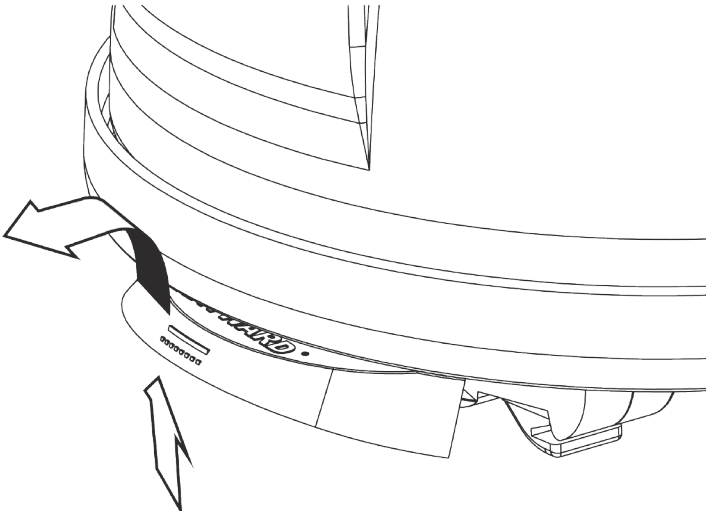

Step 3

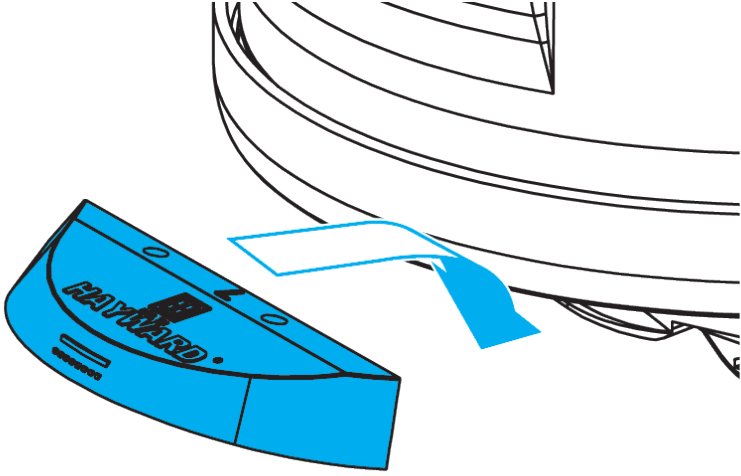

Step 4

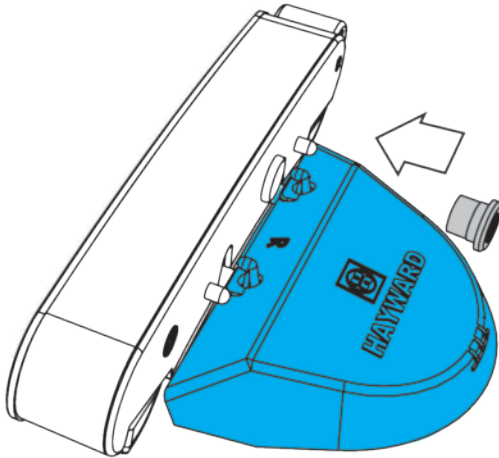

TROUBLESHOOTING

PROBLEM	CAUSES	SOLUTION
Slow/no forward movement	Lack of/improper water flow through cleaner	Check water flow with flow gauge and adjust as per Step 5.
	Blockage of the cleaner throat	Clear blockage
	Worn shoes	Replace shoes
	Worn wings	Replace wings
	Improper cleaner model for application	See your pool dealer or servicer.
Cleaner head “floats”	Air trapped in the head	Remove all air from cleaner head. Stop all air from entering the pool through the return lines. If cleaner head and hose are covered with fine bubbles, give the hose a good tug. This will release the air bubbles and allow the cleaner head to settle to the bottom of the pool until the hose is covered with bubbles again.
	The cleaner head is actually being pulled or lifted off the bottom of the pool by the, or return line flow -either at the surface or at the bottom of the pool -or both.	Readjust return outlets to prevent water flow interfering with cleaner head and/or hose.

PROBLEM	CAUSES	SOLUTION
Cleaner sticks at ladder, corners, etc.	Improper water flow	Check water flow with flow gauge and adjust as per Step 5.
	Worn shoes	Replace shoes
	Worn wings	Replace wings
	Hose too short	Install additional hose sections per installation instructions.
	Steering failure	<ol style="list-style-type: none"> 1. Check and clean rear screen, if necessary 2. Check to see that cone gear is free of debris and rotates smoothly in both directions 3. Check steering program and troubleshoot –then: <ol style="list-style-type: none"> a. clean, repair or replace gearbox b. check pod/A-frame connection and REPLACE IF NECESSARY. DO NOT ATTEMPT TO RETIGHTEN LOOSE PODS. c. check medium turbine and spindle gear assemblies



Hayward Pool Products
400 Connell Drive, Suite 6100, Berkeley Heights, NJ 07069 USA
908.351.5400 • www.hayward.com



POR ENCIMA DEL SUELO SERIES

Aspiradora para Albercas
Manual del Usuario

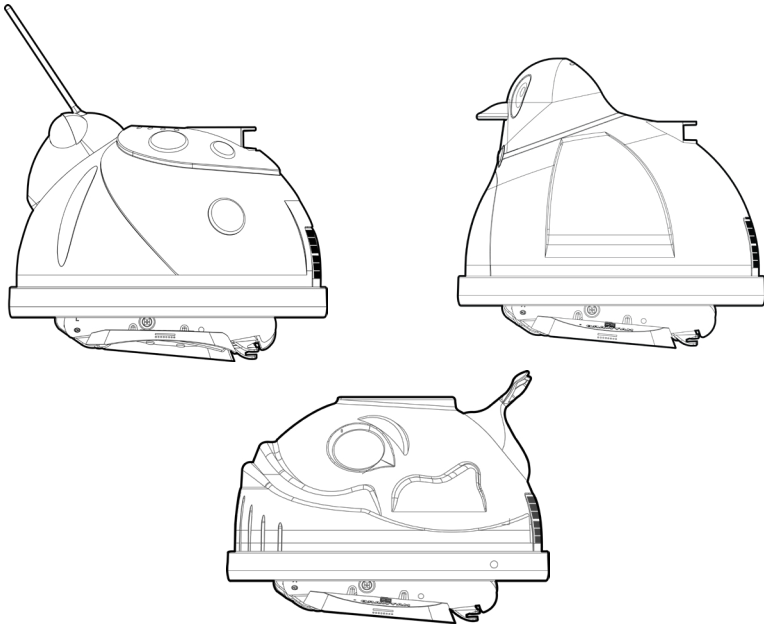

LIMPIADOR DE SUCCIÓN

Manual del Usuario

Felicidades por la compra de su sistema de limpieza automática Hayward. Si su equipo es la forma inteligente y eficiente de limpiar su alberca de arriba abajo.

El limpiador de turbina Hayward funciona a través del sistema de filtrado de su alberca y funciona con la mayoría de los sistemas. El funcionamiento de su limpiador estará relacionado con su fuente de poder. Por esto existe la remota posibilidad de que sea necesario de hacer una llamada a servicio para completar la instalación del limpiador. Esta llamada a costo del consumidor.

Por último uno o más accesorios incluyendo mangueras adicionales podrían ser necesarias para la instalación. Consulte a su distribuidor Hayward para precios y disponibilidad.

ADEVERTENCIAS DE SEGURIDAD

NO lo use para remover escombros grandes en su alberca.

RETIRE el limpiador y las mangueras antes de agregar algún químico.

NO nade con el limpiador.

Guarde el limpiador en un área segura y con sombra.

NO enrolle las mangueras se tiene que guardar estiradas.

Mantenga fuera del alcance de niños y mascotas.

RETIRE el limpiador cuando haga retro lavado.

RECUERDE La seguridad es primero.

Para más información visite www.hayward.com.

KEY



Tip



Atención



Ajuste de Presión



Bomba



CONTENIDO

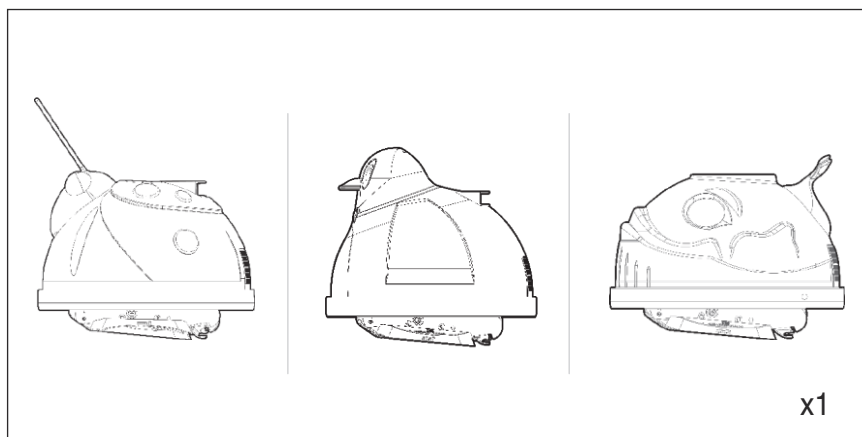

Limpiador de Alberca

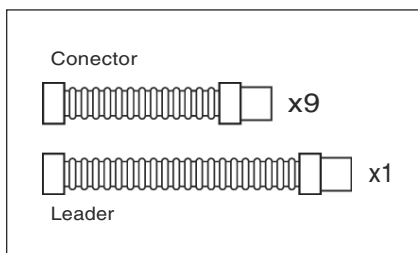

Conector/Manguera

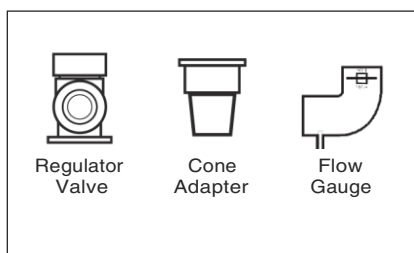

Accesorios

PREPARE LA ALBERCA

Complete los siguientes pasos para preparar la instalación:

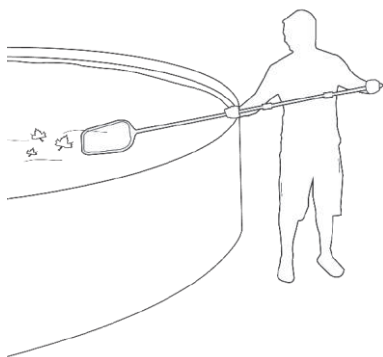

BASURA

Retire cualquier basura de su alberca.

NIVEL DE AGUA

Confirme que el nivel de agua sea el recomendado.

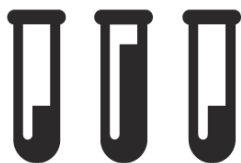

pH: 7.2 - 7.8
Cloro: 1.0-3.0 PPM
Alcalinidad Total: 80 - 120 PPM

QUÍMICA DEL AGUA

Asegúrese que el agua esté balanceada y libre de algas.

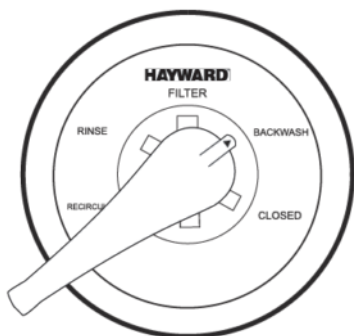

FILTRO

Limpe o haga retro lavado del filtro.

Limpe el desnatador y coladera de la bomba antes de instalar.

INSTALLATION

Mediar las Mangueras

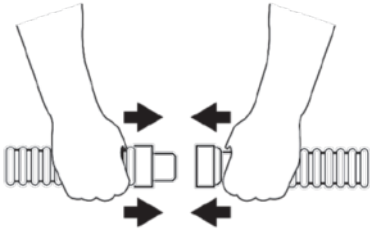

Paso 1

Conecte las secciones de mangueras.

Nota: Asegúrese de apretar bien las conexiones para evitar fugas.



TIP: Humedecer los extremos de las mangueras hace que se conecten con facilidad.



Si compró la canasta para hojas opcional, instale entre la manguera 1 y 2 empezando de la conexión a la pared.

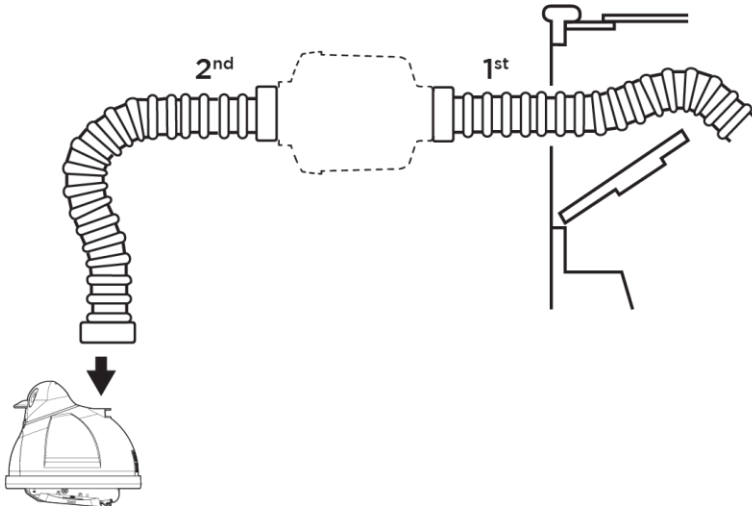

Paso 2

Extienda la manguera al punto más lejano de la alberca del lado opuesto al conector o colador **+ 2 secciones de manguera**.

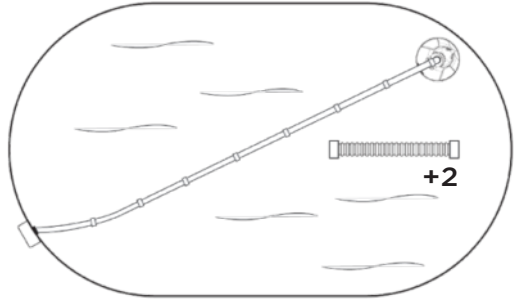
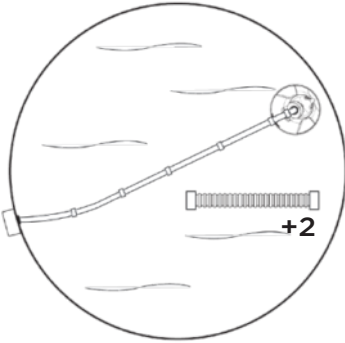

Paso 3

Llene la manguera con agua .
Inserte el medidor de flujo en la manguera líder. Coloque el C-clip en el medidor juntando con el primer tramo de manguera.

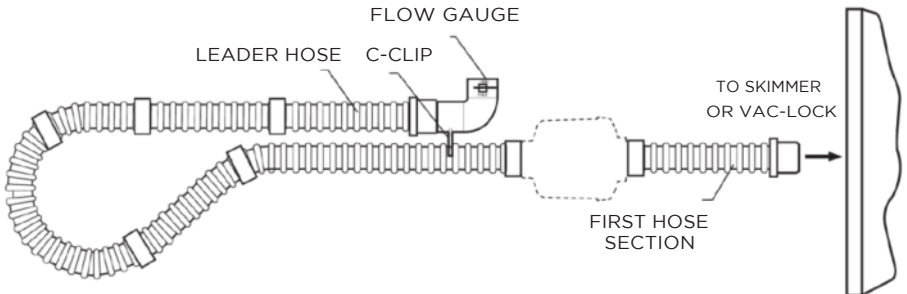

Asegúrese que el medidor de flujo esté bajo agua.

INSTALLATION

Paso 4

Conecte al colador:

Conecte el cono adaptador al primer tramo de manguera.

Nota: El extremo de la manguera va en el codo adaptador.

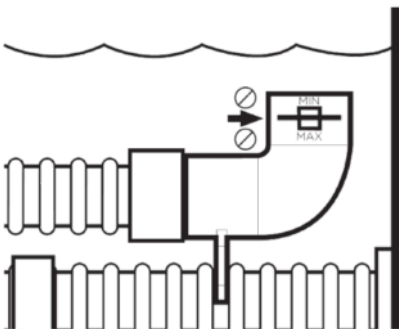
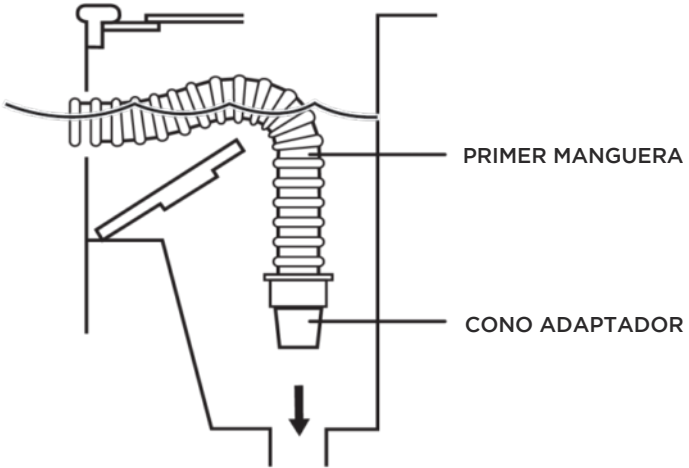

Paso 5



Cheque el flujo de agua en el medidor de flujo.

El disco negro debe estar entre las marcas "MIN" y "MAX".

Si el disco está en la posición correcta siga al paso 6.

Lectura Alta?

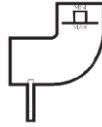

Si el disco negro está por fuera de la marca “MAX” y está conectada la manguera al colador, reduzca el flujo de agua/ aspirado usando las siguientes opciones:

- Válvula de succión en el sistema del filtro (Si tiene una)
- Válvula reguladora Hayward

Para instalar la válvula Hayward:



1. Quite la manguera del colador del cono adaptador.
2. Cierre la válvula reguladora gire el collar azul en sentido del reloj hasta que apriete.
3. Inserte la válvula reguladora en el cono adaptador del colador y el extremo de la manguera en la válvula reguladora.
4. Encienda el sistema de filtrado y deje que salga el aire del sistema.
5. Gire el collar azul hasta que el disco negro aparezca entre las marcas de “MIN” y “MAX” .

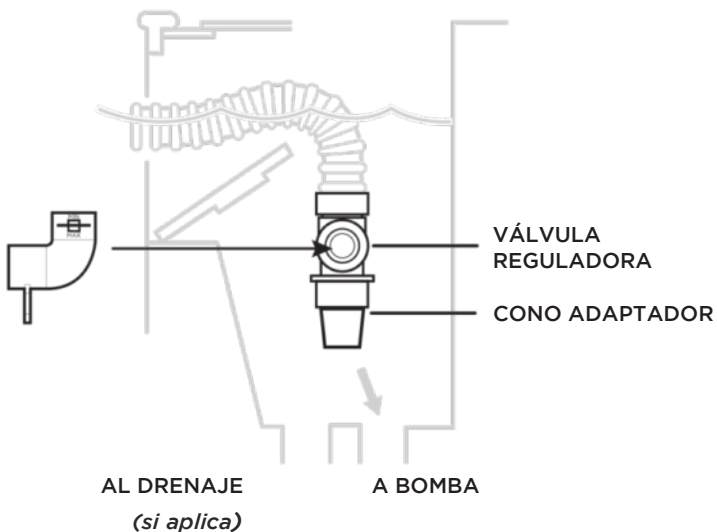

INSTALACIÓN

LEA MUY BAJO?

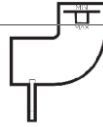

Una lectura inicial muy baja para alcanzar el nivel de flujo de agua necesario para operar el limpiador, indica que hay un problema en sistema, no en el limpiador.

La válvula reguladora no se puede usar para INCREMENTAR la lectura inicial de aspirado.

Paso 6

Sumerja el limpiador en el agua para remover todo el aire.

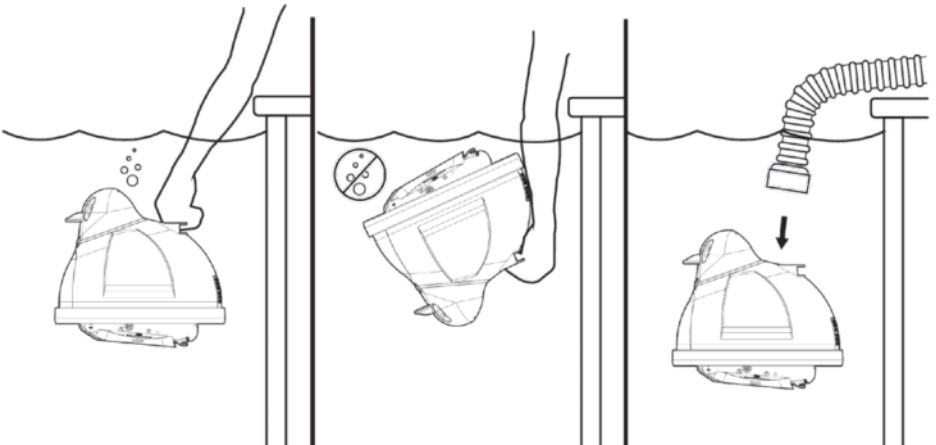



Paso 7

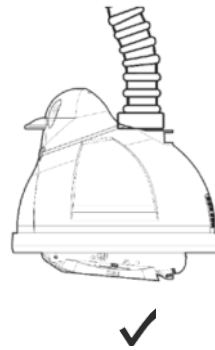
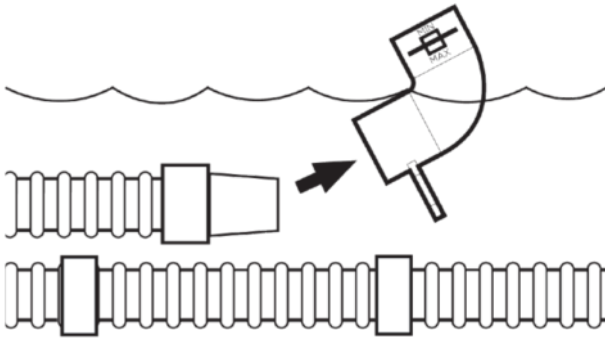

Paso 8



Prenda la Bomba y observe el Limpiador.

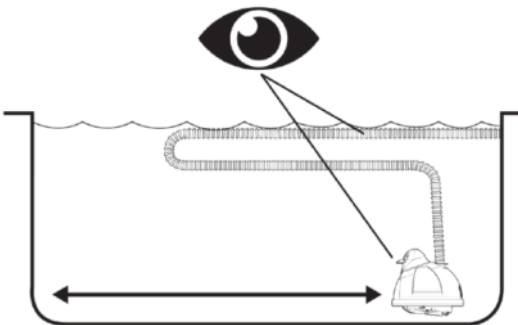

IMPORTANT TIPS



Periódicamente cheque el flujo de agua/aspirado para estar seguro que su limpiador esté funcionando bien.

Recuerde mucho aspirado es tan malo como poco.



Periódicamente cheque que la manguera este bien conectada a la fuente de succión (colador, conexión a la pared, etc.).



Desconecte la manguera del limpiador de la fuente de succión antes de hacer el retrolavado, para prevenir restricción en el flujo de agua.



NO ENROLLE LA MANGUERA

Cuando almacene su limpiador, las secciones de manguera se deben guardar estiradas. una manguera doblada pierde la habilidad de moverse propiamente.



Mangueras enrolladas pierden la garantía de Hayward.

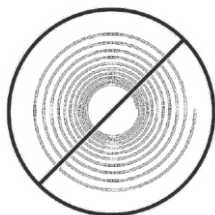

Ajuste que el agua regrese de la alberca para que la circulación del agua no interfiera con la capacidad de cobertura del limpiador.

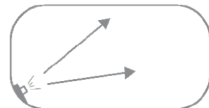
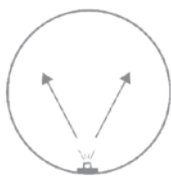
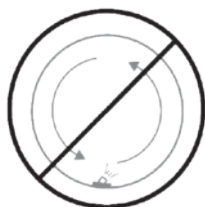

Use solamente partes y refacciones originales Hayward para un mejor operación.



Cuando el limpiador esté fuera de la alberca, desconecte la manguera del limpiador.

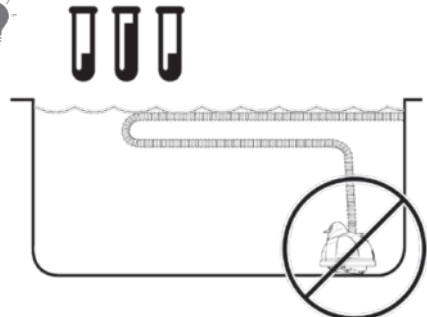

MAINTENANCE TIPS

Cheque la condición de zapatas, aletas, (“shoes, wings, and flaps”) periódicamente.

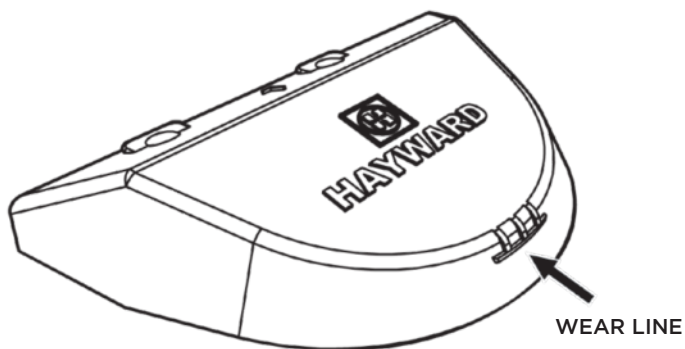
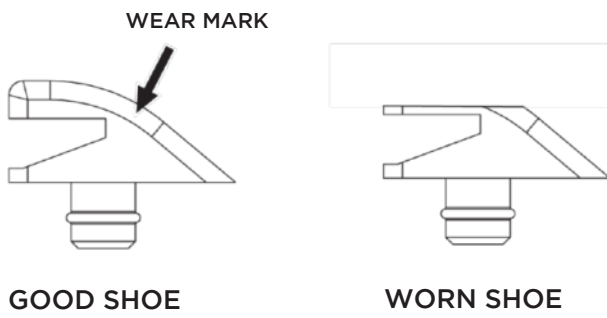

Hayward no es responsable por daños causador por mal uso del limpiador o daños causados por partes gastadas o rotas.

Remplazo de la zapata:

Paso 1

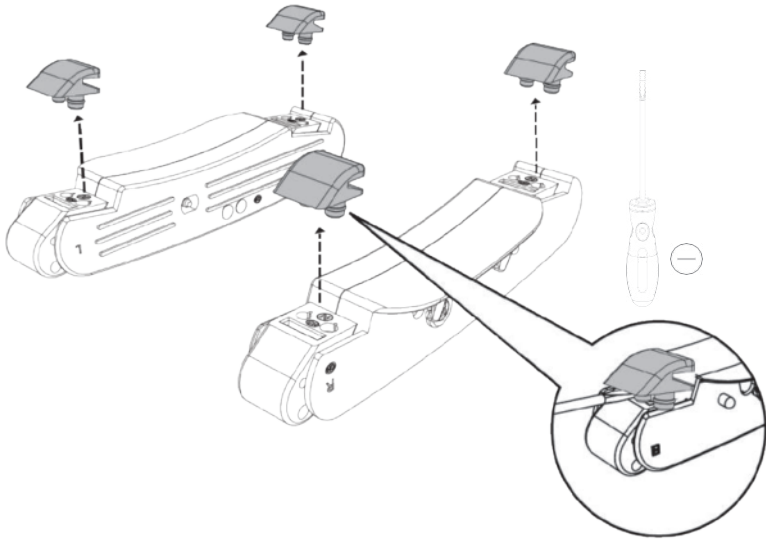

Paso 2

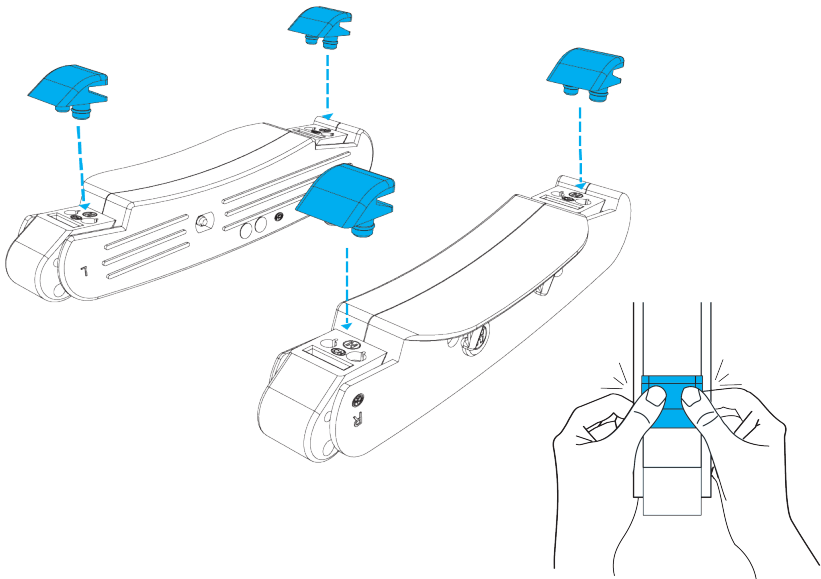

MAINTENANCE TIPS

Remplazo de la aleta:

Paso 1

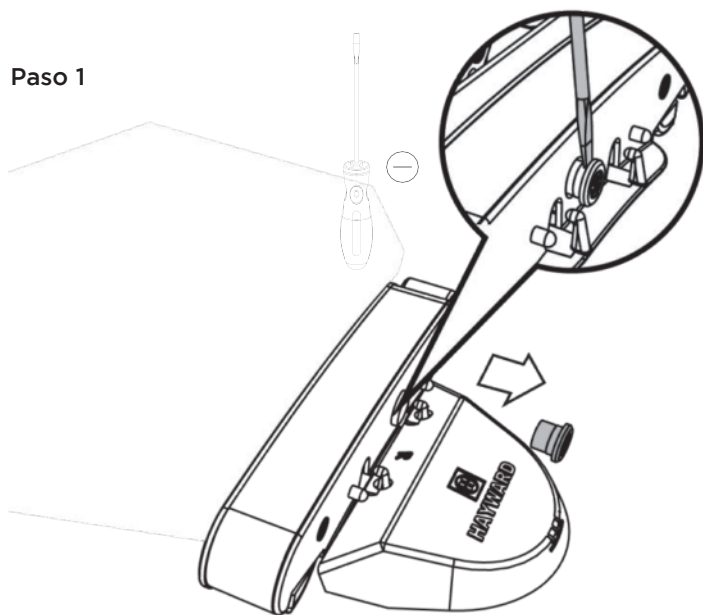

Paso 2

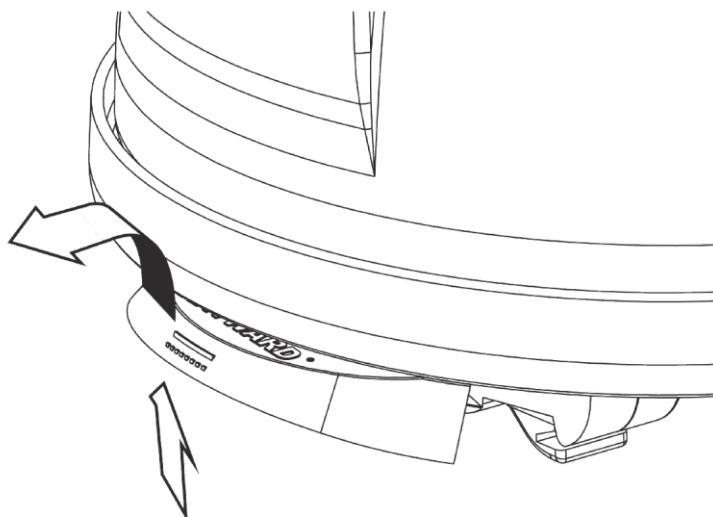

Paso 3

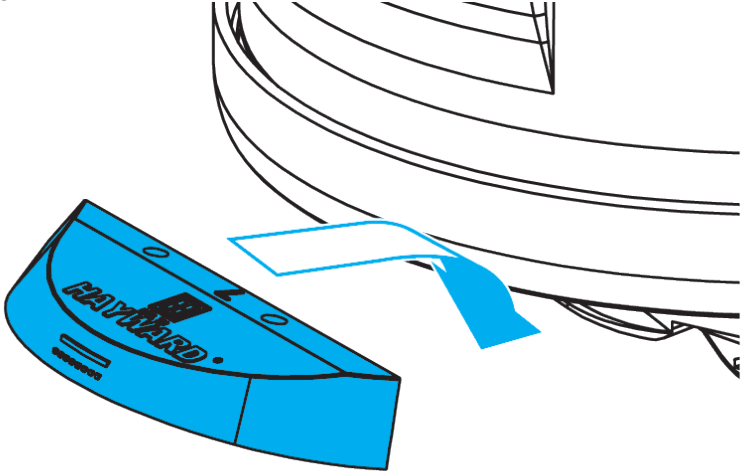

Paso 4

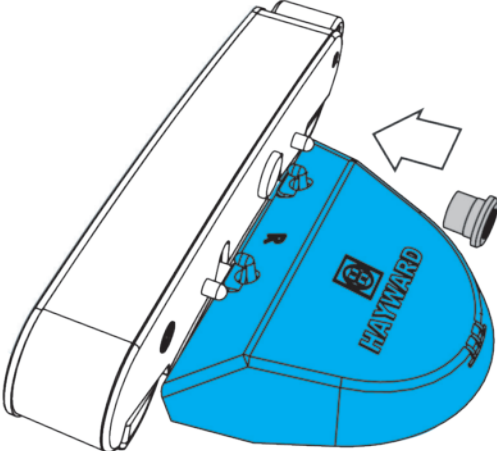

SOLUCIÓN DE PROBLEMAS

PROBLEMA	CAUSA	SOLUCIÓN
No se mueve o se mueve muy despacio	Falta /impropio flujo de agua a través del limpiador	Cheque el flujo del agua con un medidor, y ajuste Paso 5.
	La entrada del Limpiador está bloqueada	Desbloquee
	Zapata desgastada	Reemplace zapata
	Aleta desgastada	Reemplace aleta
	Modelo de limpiador inapropiado	Consulte se centro de servicio.
La cabeza del limpiador flota	Aire atrapado en la cabeza del limpiador	Remueva el aire de la cabeza. Detenga todo el aire que entra a la alberca por las líneas de regreso. De un buen tirón a la manguera para quitar las burbujas y dejar que el limpiador se asiente en el fondo de la alberca. hasta que la manguera se llene de burbujas otra vez.
	La cabeza del limpiador es jalada del fondo de la alberca por el flujo de la línea de regreso .	Reajuste las salidas de regreso para prevenir que el flujo de agua interfiera con el limpiador o mangueras.

PROBLEMA	CAUSA	SOLUCIÓN
El Limpiador se atora en escaleras esquinas, etc.	Impropio flujo de agua	Cheque el flujo de agua con un medidor y ajuste , Paso 5.
	Zapata desgastada	Reemplace zapata
	Aleta desgastada	Replace aletas
	Manguera muy corta	Instale una sección de manguera adicional
	Falla en la dirección	<ol style="list-style-type: none"> 1. Cheque y limpie la reja de atrás 2. Cheque que el cono esté libre de escombros y se mueva suavemente. 3. Cheque el programa de dirección: <ol style="list-style-type: none"> a. limpie, repare o cambie transmisión b. cheque la conexión del pod/A y cambie si es necesario. DO NOT TRATE DE APRETAR SI ESTA FLOJO EL PODS. c. cheque la turbina y el eje de la dirección



Hayward Pool Products
400 Connell Drive, Suite 6100, Berkeley Heights, NJ 07069 USA
908.351.5400 • Hayward.com



Nettoyeur automatique à aspiration pour piscine hors-sol.

Manuel d'utilisation

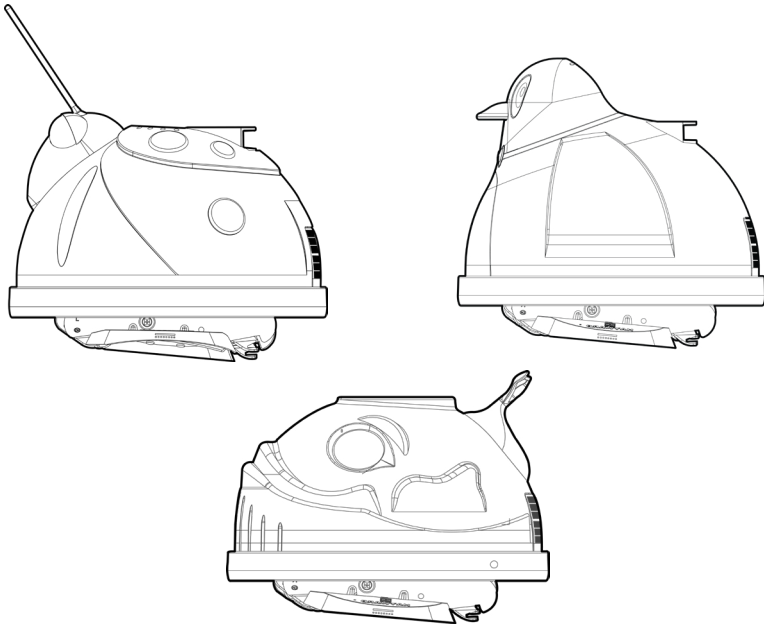

APPAREIL DE NETTOYAGE PAR ASPIRATION À TURBINE

Manuel d'utilisation

Félicitations pour l'achat de ce nettoyeur automatique à aspiration Hayward. Ce nettoyeur automatique Hayward est la solution la plus efficace et facile pour le nettoyage de votre piscine hors-sol.

Les appareils de nettoyage à turbine Hayward sont alimentés par le système de filtration de votre piscine et sont conçus pour fonctionner avec la plupart des systèmes. Les performances de l'appareil de nettoyage dans votre piscine dépendront de la performance de votre système de filtration. Parce que le fonctionnement et les performances de l'appareil de nettoyage sont dépendants du système de filtration, il se peut qu'un appel de service soit nécessaire afin de terminer complètement l'installation de votre nettoyeur. Cet appel sera aux frais du consommateur.

Enfin, il se peut que vous ayez besoin d'un ou de plusieurs des accessoires conçus pour votre nettoyeur, y compris de sections de tuyau supplémentaires, pour votre installation. Consultez votre concessionnaire Hayward pour les prix et la disponibilité.

AVERTISSEMENTS DE SÉCURITÉ

NE PAS utiliser pour nettoyer une nouvelle piscine contenant des débris de grande taille.

RETIRER l'appareil de nettoyage et le tuyau avant TOUT ajout de produits chimiques dans votre piscine.

NE PAS se baigner lorsque l'appareil de nettoyage est dans la piscine.

Entreposer l'appareil de nettoyage dans un lieu sûr et à l'ombre.

Les tuyaux doivent être maintenus droits pour l'entreposage. **NE PAS** enrouler le tuyau.

MAINTENIR HORS DE PORTÉE des enfants et des animaux domestiques. **CE NETTOYEUR AUTOMATIQUE N'EST PAS UN JOUET.**

RETIRER l'appareil de nettoyage lors d'un lavage à contre-courant.

NE PAS OUBLIER que la sécurité passe avant tout.

Pour des informations complètes sur les avertissements et la sécurité, rendez-vous sur la page www.hayward.com.

LÉGENDE



Conseil



Réglage de la pression



Attention



Pompe



CONTENU DU CARTON

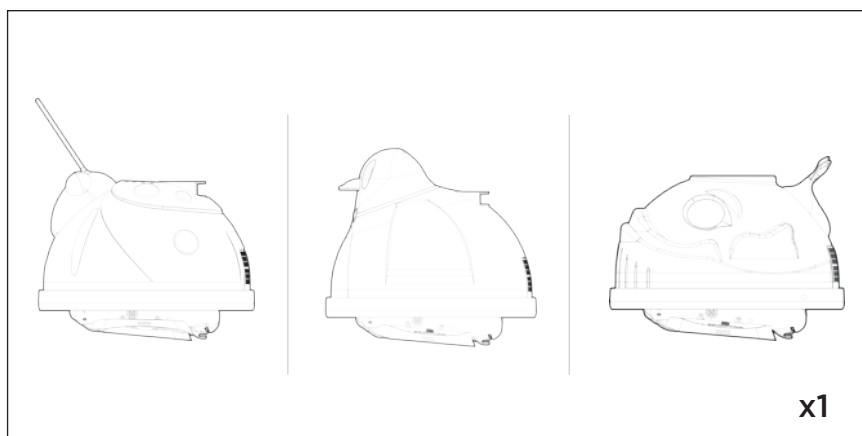

Nettoyeur automatique

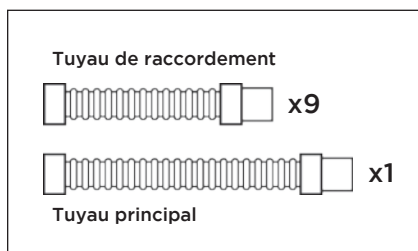

Tuyaux de raccordement et tuyau principal

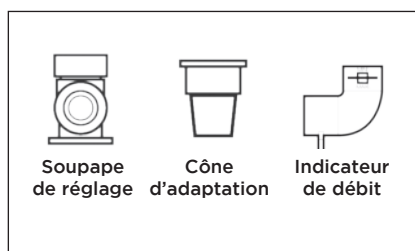

Kit d'accessoires

PRÉPARATION DE LA PISCINE

Suivre les étapes décrites ci-dessous afin de préparer la piscine pour l'installation:

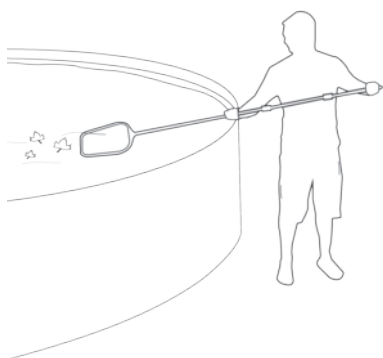

DÉBRIS

Retirer de la piscine tout débris et objet de grande taille.

NIVEAU DE L'EAU

S'assurer que le niveau d'eau est conforme aux recommandations.



pH : 7,2 - 7,8
Chlore : 1,0 - 3,0 ppm
Alcalinité totale : 80 - 120 ppm

COMPOSITION CHIMIQUE DE L'EAU

S'assurer que la composition de l'eau est bien équilibrée et que la piscine est exempte d'algues.

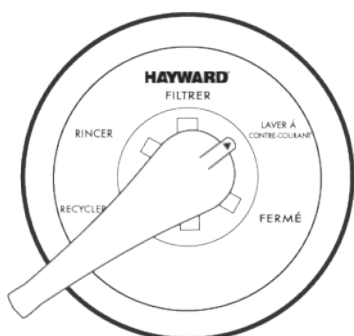

FILTRE

Nettoyer ou laver à contre-courant le filtre.

Nettoyer le panier de la pompe et de l'écumoire avant d'installer l'appareil de nettoyage.

INSTALLATION

Dimensionner le tuyau d'aspiration

Étape 1

Relier les sections de tuyau.

Remarque: s'assurer que tous les raccords sont bien serrés pour empêcher toute aspiration d'air.

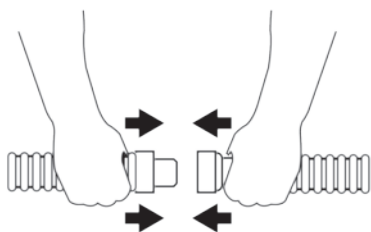

CONSEIL : *il sera plus facile de raccorder les sections de tuyau en mouillant leurs extrémités.*



Si le piège à feuilles en option est acheté, l'installer entre la première et la deuxième section de tuyau à partir de l'écumoire.

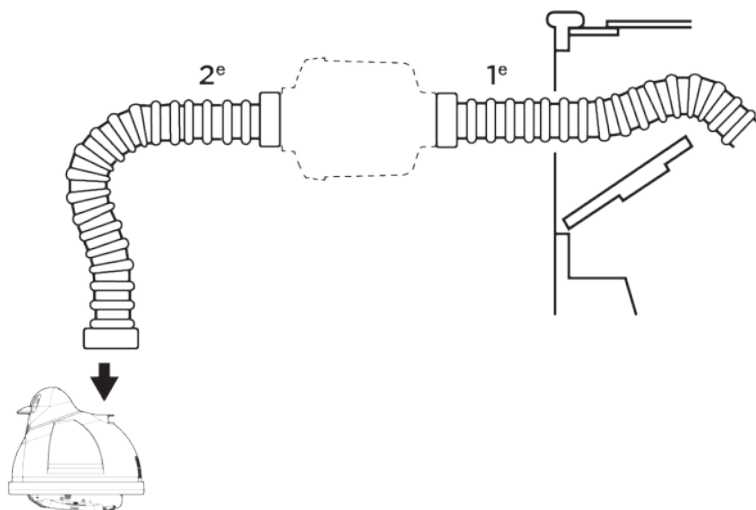

Étape 2

Étirer le tuyau vers l'emplacement le plus éloigné de la piscine en face de l'écumoire ou du raccord de la paroi + 2 sections de tuyau supplémentaires.

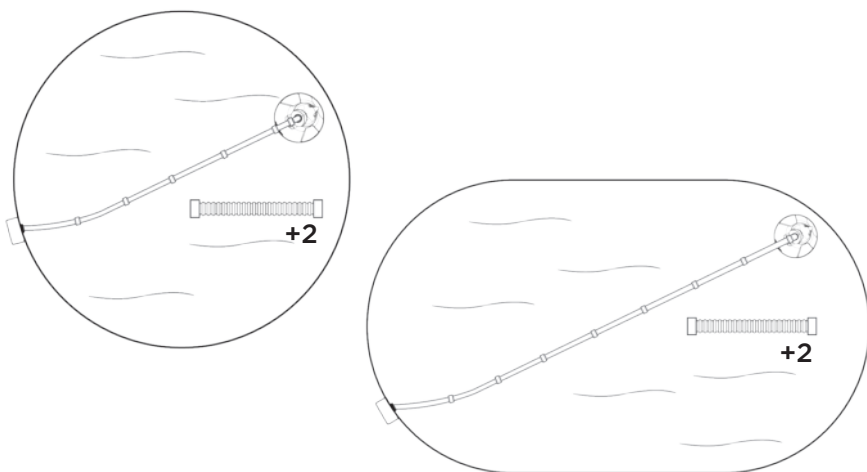

Étape 3

Remplir entièrement le tuyau avec de l'eau. Insérer l'indicateur de débit à l'extrémité du tuyau principal. Fixer l'agrafe en C de l'indicateur sur la première section de tuyau.

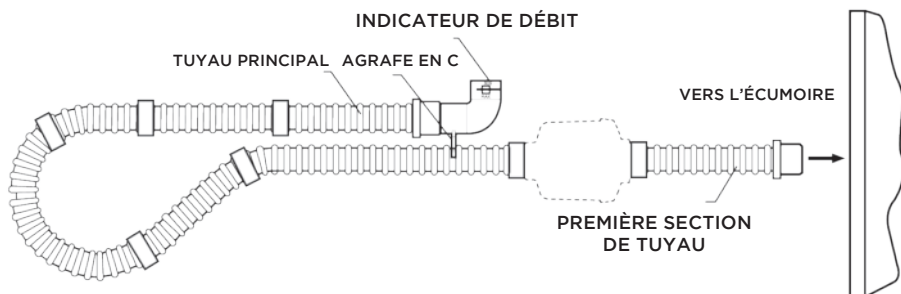

 S'assurer d'immerger l'indicateur de débit.

INSTALLATION

Étape 4

Branchement vers l'écumoire :

Raccorder le cône d'adaptation à l'extrémité mâle conique de la première section du tuyau.

Remarque: l'extrémité du tuyau s'insère dans le cône d'adaptation.

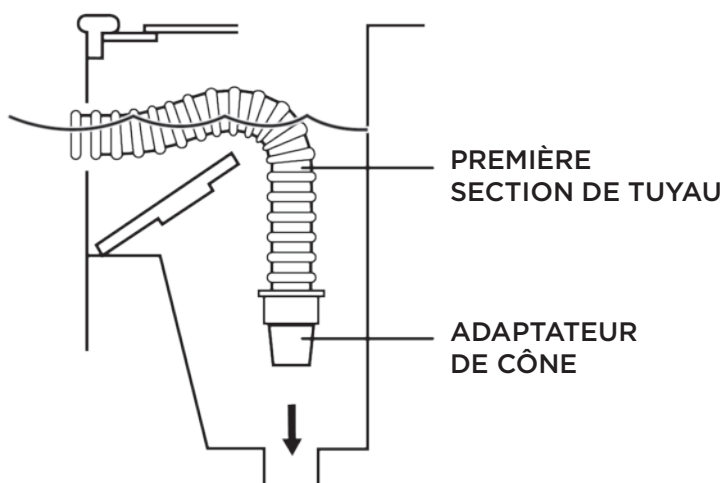

Étape 5

Contrôler le débit de l'eau sur l'indicateur de débit.

Le disque noir doit être entre les valeurs « MINI. » et « MAXI. ».

Si le disque est au bon endroit, passer à l'étape 6.

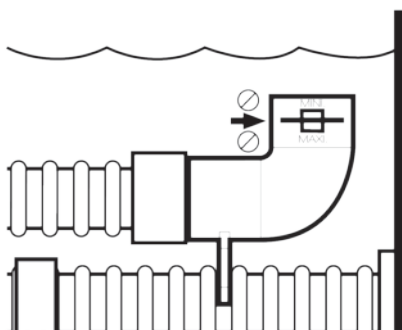

Valeur trop élevée?

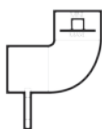

Si le disque noir est en dehors du cadran au-dessus de la marque « MAXI. » et que vous avez branché votre tuyau à l'écumoire, il vous faudra réduire le débit d'eau à l'aide :

- de la valve d'aspiration d'aspiration du système de filtration (s'il en est équipé)
- de la soupape de réglage Hayward

Pour installer la soupape de réglage Hayward :



1. Retirer le tuyau de l'écumoire.
2. Fermer la soupape de réglage en tournant la bague bleue dans le sens des aiguilles d'une montre.
3. Insérer la soupape de réglage dans le cône d'adaptation et l'extrémité du tuyau dans la soupape de réglage.
4. Mettre en route le système de filtration pour lui permettre d'éliminer complètement l'air dans le système.
5. Tourner la bague bleue dans le sens des aiguilles d'une montre jusqu'à ce que le disque noir soit entre les inscriptions « MINI. » et « MAXI. ».

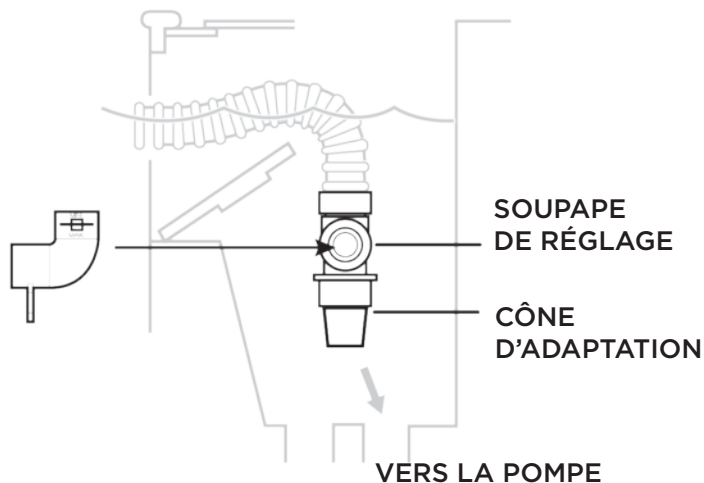

INSTALLATION

Valeur trop basse?



Une valeur d'aspiration initiale TROP basse pour être conforme au réglage du débit d'eau nécessaire pour faire fonctionner le nettoyeur correctement signifie que le système de filtration ne procure pas le débit suffisant et non pas qu'il y a un problème lié à l'appareil de nettoyage.

La soupape de réglage ne peut pas être utilisée pour AUGMENTER le débit du système.

Étape 6

Immerger l'appareil de nettoyage dans l'eau pour éliminer complètement l'air.

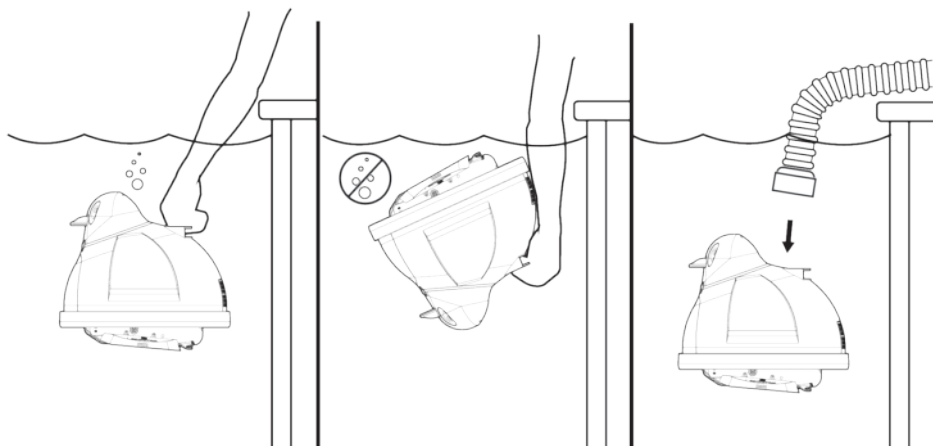



Étape 7

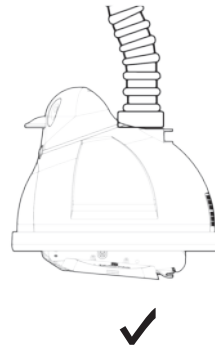
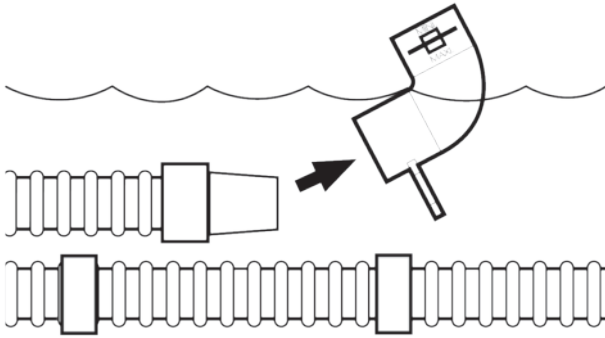

Étape 8



Mettre en marche la pompe puis observer le fonctionnement du nettoyeur.

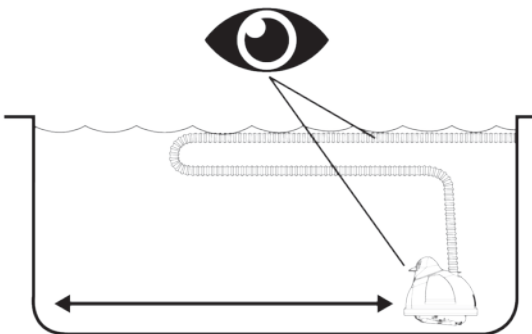

CONSEILS IMPORTANTS



Vérifier régulièrement le débit d'eau pour être certain que le nettoyeur fonctionne aussi efficacement que possible.

Ne pas oublier que trop de débit est tout aussi mauvais que trop peu.



Vérifier régulièrement que le tuyau du nettoyeur est correctement relié à sa source d'aspiration (c.-à-d. à l'écumoire)



Débrancher le tuyau du nettoyeur de l'écumoire/de la soupape de réglage avant de « laver à contre-courant », pour ne pas limiter le débit d'eau.



NE PAS ENROULER LE TUYAU

Lors de l'entreposage du nettoyeur, les sections de tuyau doivent être maintenues droites. Un tuyau enroulé conserve cette forme et empêchera le nettoyeur de se déplacer correctement.



Les tuyaux enroulés ne sont pas couverts par la garantie Hayward.



Diriger le courant de retour de l'eau vers le centre de la piscine afin que la circulation de l'eau ne limite pas la capacité de nettoyage de l'appareil.

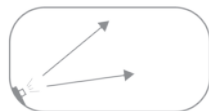
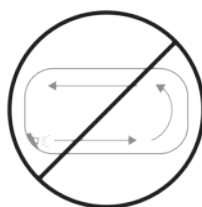
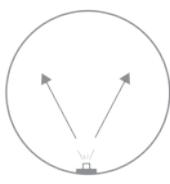
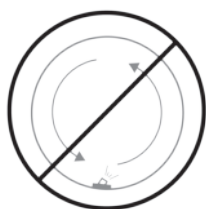

Utiliser uniquement des tuyaux et des pièces de rechange d'origine Hayward pour assurer un fonctionnement adéquat.



Lorsque le nettoyeur n'est pas dans la piscine, débrancher toujours le tuyau principal de celui-ci.

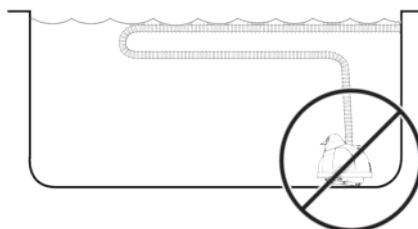
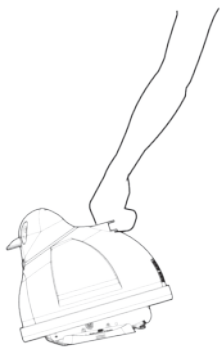

CONSEILS D'ENTRETIEN

Vérifier régulièrement l'état des « semelles, ailes et volets »

INDICATEUR D'USURE

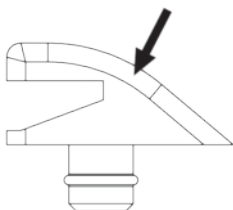

SEMELLE CORRECTE

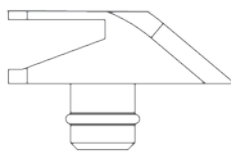

SEMELLE USÉE

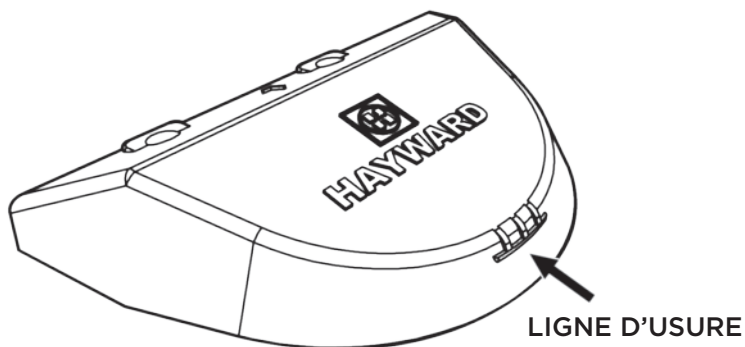

Hayward n'est pas responsable des dommages causés par une mauvaise utilisation de l'appareil de nettoyage ou par des pièces usées ou brisées.

Remplacement des semelles:

Étape 1

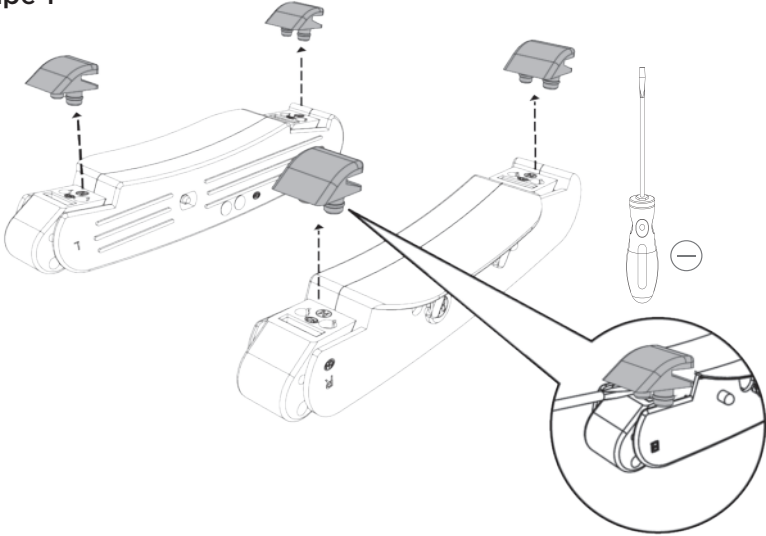

Étape 2

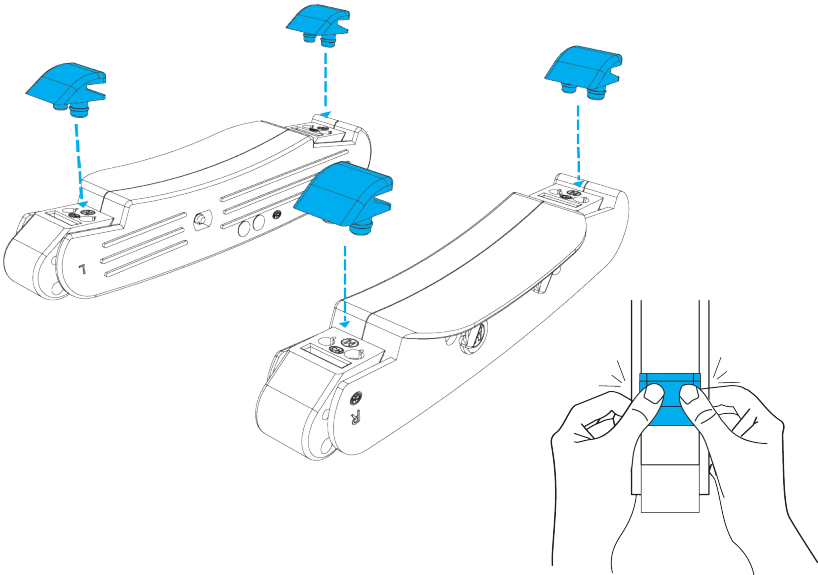

CONSEILS D'ENTRETIEN

Remplacement des ailes:

Étape 1

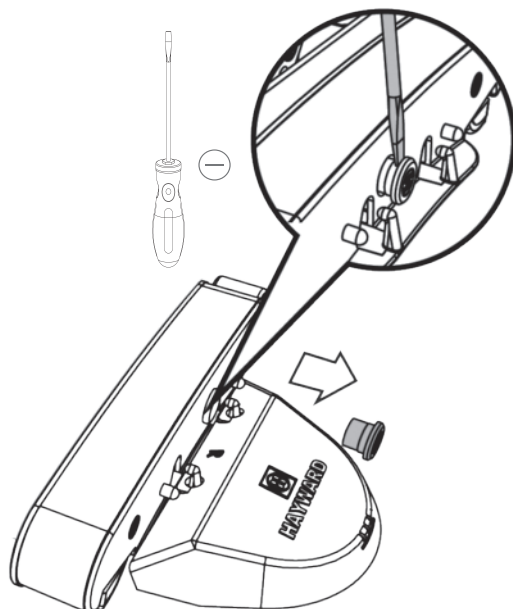

Étape 2

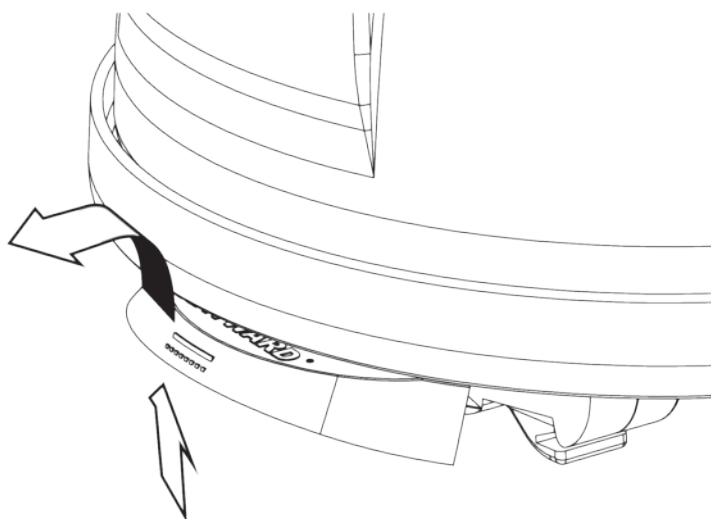

Étape 3

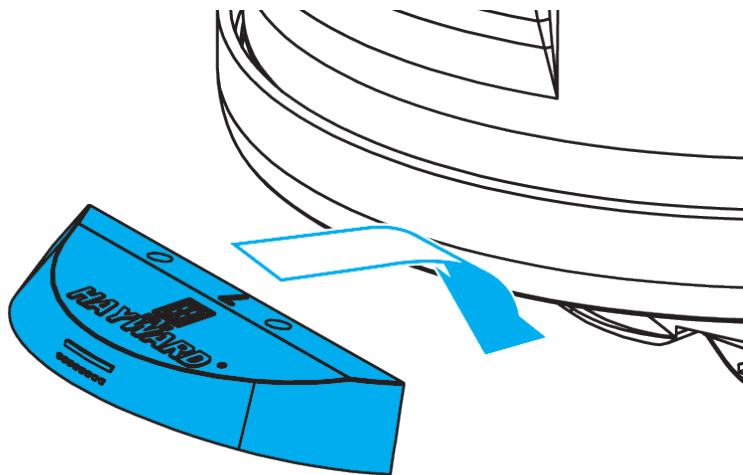

Étape 4

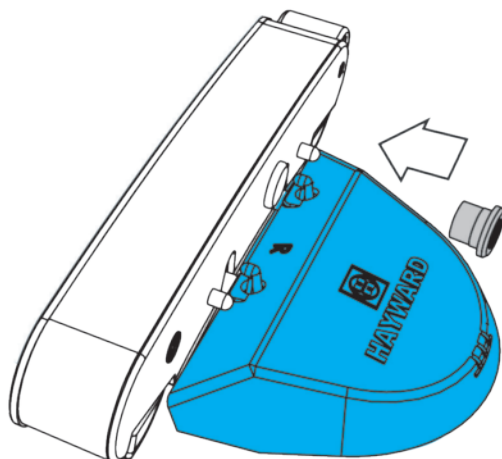

DÉPANNAGE

PROBLÈME	CAUSES	SOLUTION
Aucun mouvement vers l'avant ou mouvement vers l'avant lent	Débit d'eau manquant ou inadéquat dans l'appareil de nettoyage	Vérifier le débit de l'eau à l'aide de l'indicateur de débit puis le régler comme indiqué à l'étape 5.
	Obstruction de la gorge de l'appareil de nettoyage	Dégager l'obstruction
	Semelles usées	Remplacer les semelles
	Ailes usées	Remplacer les ailes
	Modèle d'appareil de nettoyage inadéquat pour l'application	Consulter un concessionnaire de piscines ou un dépanneur.
La tête de l'appareil de nettoyage « flotte »	Air piégé dans la tête de l'appareil de nettoyage	Retirer tout l'air de la tête de l'appareil de nettoyage. Empêcher l'air d'entrer dans la piscine par les conduites de retour. Si de fines bulles couvrent la tête de l'appareil de nettoyage et le tuyau, tirer vigoureusement ce dernier. Cela libèrera les bulles d'air, permettant ainsi à la tête de l'appareil de nettoyage de couler au fond de la piscine.
	Les buses de refoulement repoussent le nettoyeur vers la surface ou entre deux eaux.	Rediriger les buses de refoulement afin que la circulation de l'eau n'interfère pas avec le fonctionnement du nettoyeur ou du tuyau.

PROBLÈME	CAUSES	SOLUTION
L'appareil de nettoyage est coincé dans l'échelle, les coins, etc.	Débit d'eau inadéquat	Vérifier le débit de l'eau à l'aide de l'indicateur de débit puis le régler comme indiqué à l'étape 5.
	Semelles usées	Remplacer les semelles
	Ailes usées	Remplacer les ailes
	Le tuyau est trop court	Installer des sections de tuyau supplémentaires en suivant les instructions d'installation.
	Problème de direction	<ol style="list-style-type: none"> 1. Vérifier et nettoyer la grille arrière, si nécessaire 2. Vérifier que l'engrenage du cône est exempt de débris et tourne de manière fluide dans les deux sens 3. Vérifier le programme de direction et la section de dépannage, puis : <ol style="list-style-type: none"> a. nettoyer, réparer ou remplacer la boîte d'engrenages b. vérifier la liaison entre la pièce en A et le patin puis REMPLACER, SI NÉCESSAIRE. NE PAS ESSAYER DE RESSERRER DES PATINS MAL FIXÉS. c. vérifier les ensembles de la turbine moyenne et de l'engrenage de l'axe



Hayward Pool Products
400 Connell Drive, Suite 6100, Berkeley Heights, NJ 07069 USA
908.351.5400 • Hayward.com