

OmniLogic[®]

Expansion Panel for OmniLogic

Owner's Manual

Contents	
	Before You Begin.....1
	Overview.....1
	Mounting Equipment.....3
	Plumbing.....5
	Wiring.....6
	System Startup.....16

HLEXPAND

Hayward Industries
1415 Vantage Park Dr., Suite 400
Charlotte, NC 28203
Phone: (908) 355-7995
www.hayward.com



HAYWARD®

IMPORTANT SAFETY INSTRUCTIONS

When using this electrical equipment, basic safety precautions should always be followed, including the following:

- **READ AND FOLLOW ALL INSTRUCTIONS**
- **WARNING:** Disconnect all AC power during installation.
- **WARNING:** Water in excess of 100 degrees Fahrenheit may be hazardous to your health.
- **WARNING:** To reduce the risk of injury, do not permit children to use this product unless they are closely supervised at all times.
- **WARNING:** Do not use the OmniLogic to control fire pits or related fire equipment.
- A green colored terminal marked “Grounding” is located inside the wiring compartment. To reduce the risk of electric shock, this terminal must be connected to the grounding means provided in the electric supply service panel with a continuous copper wire equivalent in size to the circuit conductors supplying the equipment.
- One bonding lug for US models is provided on the external surface. To reduce the risk of electric shock, connect the local common bonding grid in the area of the swimming pool, spa, or hot tub to these terminals with an insulated or bare copper conductor not smaller than 8 AWG US / 6 AWG Canada.
- All field installed metal components such as rails, ladders, drains, or other similar hardware within 3 meters of the pool, spa or hot tub shall be bonded to the equipment grounding bus with copper conductors not smaller than 8 AWG US / 6 AWG Canada.
- **SAVE THESE INSTRUCTIONS**



FCC Statement

This device complies with part 15 of the FCC rules. Operation is subject to the following two conditions: (1) This device may not cause harmful interference, and (2) this device must accept any interference received, including interference that may cause undesired operation.

Changes or modifications not expressly approved by Hayward could void the user's authority to operate this equipment.

NOTE: This equipment has been tested and found to comply with the limits for a Class B digital device, pursuant to Part 15 of the FCC Rules. These limits are designed to provide reasonable protection against harmful interference in a residential installation. This equipment generates, uses and can radiate radio frequency energy and, if not installed and used in accordance with the instructions, may cause harmful interference to radio communications. However, there is no guarantee that interference will not occur in a particular installation. If this equipment does cause harmful interference to radio or television reception, which can be determined by turning the equipment off and on, the user is encouraged to try to correct the interference by one or more of the following measures:

- Reorient or relocate the receiving antenna.
- Increase the separation between the equipment and receiver.
- Connect the equipment into an outlet on a circuit different from that to which the receiver is connected.
- Consult the dealer or an experienced radio / TV technician for help.

Industry Canada Statement

This Class B digital apparatus complies with Canadian ICES-003.

Cet appareil numérique de la classe B est conforme à la norme NMB-003 du Canada.

The term "IC" before the certification / registration number only signifies that the Industry Canada technical specifications were met.



Table of Contents

Before you Begin	Before you Begin.....	1
Preparing Mounting Equipment	OmniLogic Enclosure.....	3
	Temperature Sensors.....	4
	Optional Chlorination.....	4
	Optional HL-CHEM Sensing Kit.....	4
	Optional AQL-CHEM2 pH Dispensing.....	4
	Optional Web Connected Devices.....	4
	Optional HLWLAN.....	4
	Optional Valve Actuators.....	5
Plumbing	TurboCell.....	5
	Flow Switch.....	5
Electrical Wiring	Main Service.....	7
	Grounding and Bonding.....	7
	Circuit Breaker Installation and Wiring.....	7
	General Purpose Outlet.....	7
	HLEXPAND Power.....	7
	Pool Equipment Connection Table.....	8
	High Voltage Pool Equipment.....	9
	Low Voltage Wiring.....	10
System Startup	System Startup.....	16
Warranty	OmniLogic Limited Warranty.....	19



Before you Begin

The HLEXPAND is an expansion panel accessory for the Hayward OmniLogic HLBASE pool control. The HLEXPAND increases the number of sensor/external inputs, high voltage outputs (for pumps, water features, outdoor lights, etc.), low voltage outputs (for heaters, variable speed pumps, valve actuators, etc.) and adds an additional chlorinator output to your existing OmniLogic, expanding the functionality of the HLBASE. A circuit breaker panel is included in the HLEXPAND for easy wiring to the additional equipment. For remote access through the internet, the HLEXPAND connects to the OmniLogic as well as the home's router using a standard Cat5/6 Ethernet cable which can be run up to 200 ft. away. If a hard wired connection to the router is difficult, a Hayward HLWLAN wireless transceiver may be used instead.

Although the HLEXPAND looks similar to the OmniLogic, there is no touchscreen and all connected equipment is controlled through the OmniLogic's touchscreen, remote terminals, and web connected devices.

What's Included

Before attempting to install the HLEXPAND, check that the following components have been included in the package:

- OmniLogic Expansion Panel
- (3) Temperature sensors with 15 ft. (5m) cable, hose clamp
- 15 ft. Ethernet cable
- Ferrite bead (for HLWLAN)
- Spare Main Board fuses

What's NOT Included

Some of the additional items that you may need to complete the installation include:

Circuit breakers

None are included with HLEXPAND—see page 7 and inside door label for suitable breakers

Wire

Wire/conduit for 100A service from main panel to HLEXPAND
Wire/conduit for filter pump and other high voltage loads
Wire for remote heater control and other low voltage devices
Wire for bonding

Miscellaneous

Optional utility electrical outlet and weatherproof cover (for mounting on lower right side of HLEXPAND)
Mounting hardware (screws, bolts, etc.) for mounting HLEXPAND
Valve Actuators (to automate valve functions)

Accessory Products - Order Separately

HLRELAYBANK	Additional relay pack adds 4 high voltage relays
HLRELAY	Single high voltage relay kit
HLIOEXPAND	Input/Output Expander Board adds 4 additional sensor/external inputs, 4 heater/low voltage outputs, and 4 actuator outputs
HLWLAN	Wireless home network connectivity - eliminates the need to hard wire the HLEXPAND to the home's router/access point
HL-CHEM	ORP & pH Sensing Kit for monitoring and controlling pool chemistry
GVA-24	Valve Actuator
V&A-xx	Valve & Actuator (xx=1P (1.5" pos. seal), -2P (2" pos. seal)
TCELLS340	Chlorinator Cell - generates chlorine for pools up to 40,000 gallons
TCELLS325	Chlorinator Cell - generates chlorine for pools up to 25,000 gallons
TCELLS318	Chlorinator Cell - generates chlorine for pools up to 18,000 gallons
TCELLS315	Chlorinator Cell - generates chlorine for pools up to 15,000 gallons
P-KIT	Chlorination plumbing kit containing flow switch and cell unions
AQL-CHEM2	CO ₂ dispensing kit for pH control
HL-CHEM4-ACID	Liquid acid feeder for pH control
HL-CHEM4-CHLOR	Liquid chlorine feeder
CL200	Chlorine tablet feeder

NOTE: Before installing this product as part of a saline water purification system in a pool or spa using natural stone for coping or for immediately adjacent patios/decking, a qualified stone installation specialist should be consulted regarding the appropriate type, installation, sealant (if any) and maintenance of stone used around a saline pool with an electronic chlorine generator in your particular location and circumstances.

NOTE: The use of dry acid (sodium bisulfate) to adjust pool pH is discouraged especially in arid regions where pool water is subject to excessive evaporation and is not commonly diluted with fresh water. Dry acid can cause a buildup of by-products that can damage your chlorinator cell.

Overview

It is important to completely read through this manual before attempting to install, configure or operate this unit. Many of the installation steps are the same as the OmniLogic. If installing both units at the same time, it's recommended to install the OmniLogic first but do not start the configuration process until after the HLEXPAND has been installed and wired. Also, skip the OmniLogic's Ethernet connection and refer to instructions in this manual.

Features

The HLEXPAND adds the following features to your OmniLogic:

- control up to 4 (expandable to 8 using HLRELAYBANK) high voltage (120/240V) relays to control pumps, pool lights, yard lights, water features, chemical dispensers and more. Two more relays (HLRELAY) can be added to the HLEXPAND for a total of 10
- control up to 4 (expandable to 8 with HLIOEXPAND) automatic valve actuators including pool and spa valves, water feature valves, cleaner valves and more
- control up to 4 (expandable to 8 with HLIOEXPAND) heaters or low voltage equipment including gas heaters, electric heat pumps, and solar heaters as well as various low voltage devices
- controls up to 16 EcoStar variable speed pumps without the use of a relay
- inputs for up to 4 temperature sensors or external input devices (expandable to 8 with HLIOEXPAND)
- Ethernet ports for connection to OmniLogic and to the home's router/access point
- 100A electrical subpanel that can accommodate up to 12 circuit breakers
- connection for Hayward TurboCell used to generate chlorine for an additional body of water
- connection for flow switch used to detect water flow
- input for HL-CHEM ORP and pH sensing kit for an additional body of water

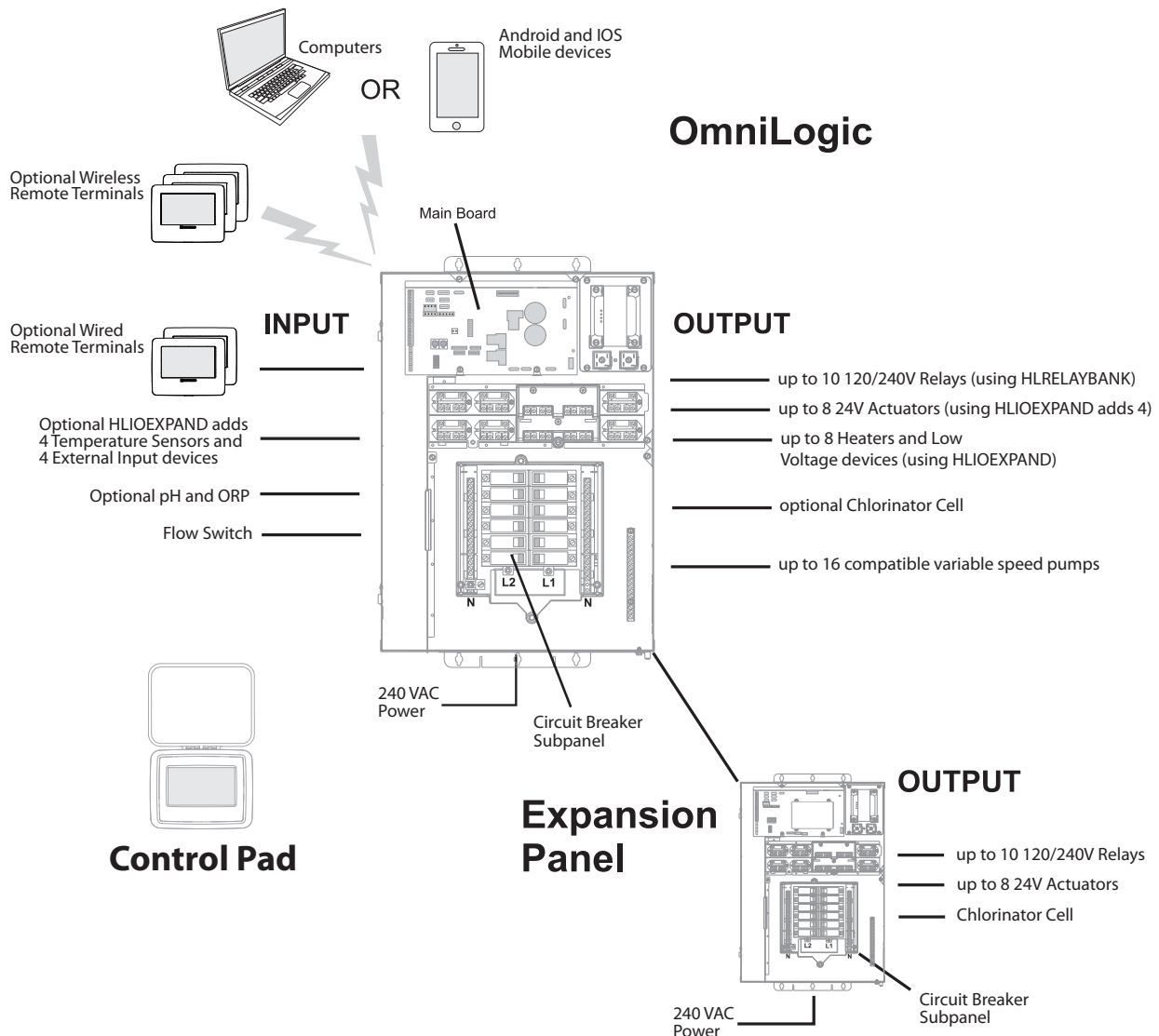



Installation Steps

DANGER of Death, Injury or Property Damage if procedure not followed. Dead front removal is required for this installation. Power to the HLEXPAND MUST be shut off whenever the dead front is removed. This means a complete shutdown of power to the entire Expansion Panel.

This manual assumes that you have already installed the OmniLogic that will control this Expansion Panel. Follow the similar installation steps on the following pages.

Mounting the Equipment

HLEXPAND Enclosure

The HLEXPAND is contained in a raintight enclosure that is suitable for outdoor mounting. The control must be mounted a minimum of 6 ft. (2 meters) horizontal distance from the pool/spa (or more, if local codes require). The HLEXPAND is designed to mount vertically on a flat surface with the knockouts facing downward. Because the enclosure also acts as a heat sink (disperses heat from inside the box), it is important not to block the four sides of the control. Do not mount the HLEXPAND inside a panel or tightly enclosed area.

When selecting a location, note that the standard cables supplied with the included temperature sensors, as well as optional accessories like a Hayward Turbo-Cell and actuators are all 15 ft. (5m) long. Also, a 15 ft. Ethernet cable is included for connection to the OmniLogic so if mounting further away, you will need to supply your own cable. An additional Ethernet connection must be made to the home's router or a HLWLAN if remote web connected devices are to be used.

The HLEXPAND weighs close to 60lbs and will require two people to position and install. Select the proper location and mounting hardware given the size and weight of the unit. The mounting brackets require a total of 6 mounting bolts to fasten the enclosure to the mounting surface.

Note that there is a heat sink on the back of the enclosure. In all cases the heat sink on the back of the enclosure should not contact the wall behind the panel. This restricts air flow and makes the heat sink less efficient. A minimum separation of 1/8" (except for vinyl siding) should be maintained between any heat sink pin and the siding on the wall behind the enclosure. In the case of a flat wall the mounting flanges on the enclosure ensure that the minimum clearance is maintained. For shingles, clapboards or other siding with a non-flat profile, the installer must ensure the minimum separation. Refer to the adjacent diagram.

Special Installation Instructions for Vinyl Siding

IMPORTANT: The heat sink on the back of the HLEXPAND enclosure cannot be allowed to contact vinyl siding; during normal chlorinator operation the heat sink pins get warm enough to deform vinyl siding on contact. An increased minimum separation of 3/8" should be maintained between any heat sink pin and the vinyl siding behind the enclosure.

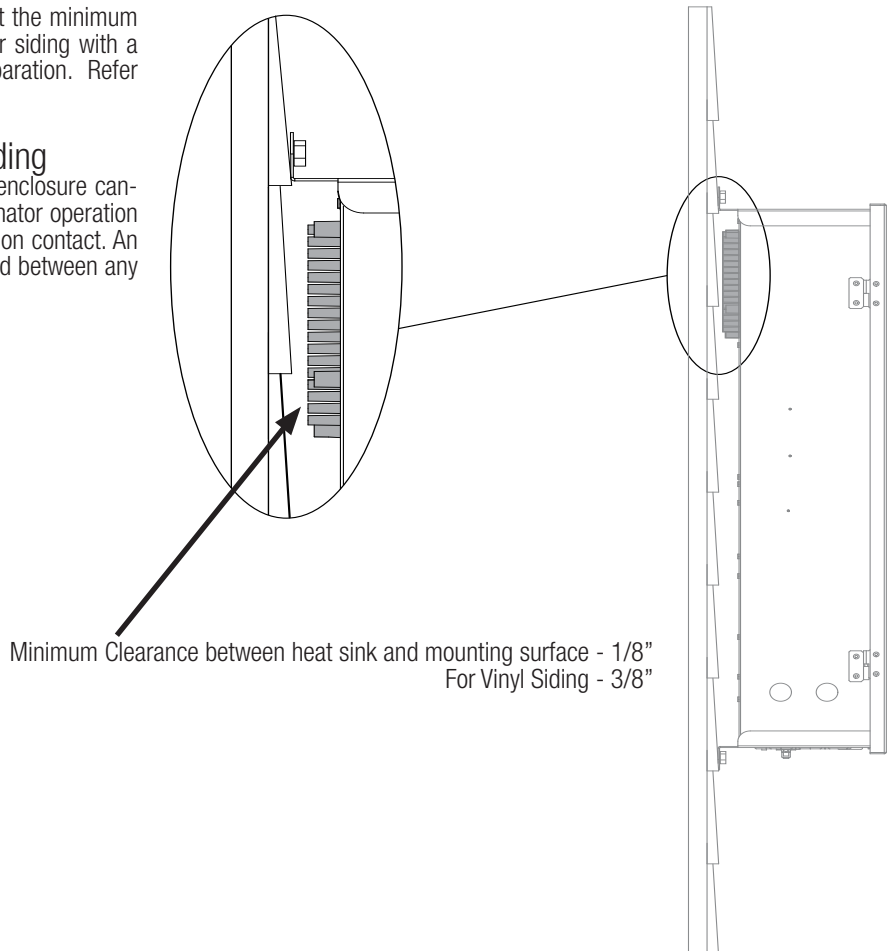



HAYWARD®

Temperature Sensors

Three sensors are included with the HLEXPAND. Depending on your application, these sensors may or may not be used. If more than 2 bodies of water will be managed by the HLBASE you will need to use the Pool and/or Spa water temperature sensors on the HLEXPAND. The air temperature sensor is optional and the solar sensor is required only if a second solar heating function is enabled.

Water Sensor

This sensor is used to measure the pool/spa temperature and is installed in the filtration plumbing after the filter but before either the solar or conventionally fueled heaters—refer to the plumbing overview diagram.

1. Drill a 3/8" (10mm) diameter hole in the PVC piping and remove all chips and burrs.
2. Insert sensor until O-ring collar sits flush on the hole.
3. Position hose clamp over the sensor and gently tighten until O-ring makes an adequate seal. Do not overtighten.

Air Sensor

The HLEXPAND's air sensor is not used in any of the pool's functions and is provided as a convenient way of monitoring an additional airspace. This sensor can be mounted indoors or outside but not in direct sunlight. **IMPORTANT:** The Freeze Protection function will only reference the OmniLogic air sensor, not the HLEXPAND's air sensor.

Solar Sensor

For solar applications, mount the sensor near the solar collector array so that it is exposed to the same sunlight as the collectors. Use additional cable (20 AWG) if necessary.

Optional Chlorination Function

The HLBASE offers optional chlorination for the primary body/bodies of water. The HLEXPAND can provide chlorination for an additional body of water if needed. This function requires a chlorinator cell and P-KIT (flow switch and cell unions) purchased separately at your Hayward dealer. Choose a chlorinator cell model based on the size of your additional pool/spa. The following models are available:

TCELLS340 for pools up to 40,000 gallons
TCELLS325 for pools up to 25,000 gallons
TCELLS318 for pools up to 18,000 gallons
TCELLS315 for pools up to 15,000 gallons

Refer to page 5 of the OmniLogic manual for plumbing and wiring instructions.

Optional HL-CHEM Sensing Kit

Like the OmniLogic, the HLEXPAND supports the HL-CHEM ORP and pH sensing kit for additional bodies of water. The HL-CHEM functions in the same manner as described in the OmniLogic manual and can be used to control chlorine generation/dispensing and pH dispensing. Wiring and plumbing requirements for the HL-CHEM should be considered before installing the HLEXPAND. Refer to the HL-CHEM manual for specific installation information. **NOTE:** OmniLogic and HLEXPAND are not compatible with AQL-CHEM.

Optional AQL-CHEM2 CO₂ Dispensing Kit

The AQL-CHEM2 is a CO₂ dispensing device that connects directly to the HLEXPAND. When used with an HL-CHEM, the HLEXPAND will sense the pH level and automatically dispense the correct amount of CO₂ to control the water's pH to the desired level. Wiring and plumbing requirements for the AQL-CHEM2 should be considered before installing the HLEXPAND. Refer to the AQL-CHEM2 manual for specific installation information.

Optional AQL-CHEM4-ACID, AQL-CHEM4-CHLOR Dispensing Systems

The OmniLogic and HLEXPAND can be used to control Hayward chemical dispensing systems. These units are large capacity, with 15 gallon pump and tank and are capable of automatically dispensing acid for pH control (AQL-CHEM4-ACID) or liquid chlorine for sanitization (AQL-CHEM4-CHLOR).

Ethernet and Web Connected Devices

The OmniLogic offers Ethernet connectivity to the web through the home's network. Once connected, web enabled devices such as a PC, laptop, tablet or phone can be used to control and monitor the OmniLogic. For this functionality, two Ethernet connections must be made to the HLEXPAND. First, a connection from the HLEXPAND to the OmniLogic using the provided 15 ft. cable allows communication between the two units. Second, an Ethernet cable must be run from the HLEXPAND to the home's router/access point or to a Hayward HLWLAN.

HLWLAN

If running Ethernet cable from the home's router/access point to the HLEXPAND is impractical, an optional HLWLAN can be used (see page 14). The HLWLAN is a 802.11b/g/n transceiver kit that can make a wireless connection up to 250 ft. to the home's router/access point preventing the need to run cable for web access. Refer to the HLWLAN Owner's Manual for wiring and configuration information.



Optional Valve Actuators

Like the OmniLogic, optional actuators can be used with the HLEXPAND. Note that the internal cams in the actuator may also have to be adjusted depending on the way the actuator is mounted on the valve and the desired valve action.

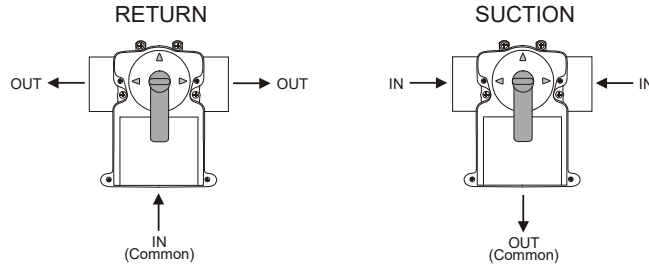

Plumbing

Optional TurboCell

The TurboCell must be plumbed AFTER the filter and heater. If installed on a pool/spa combination system, the cell must be plumbed BEFORE the pool/spa return valve in order to allow proper chlorination of both the pool and the spa. Refer to plumbing diagram below:

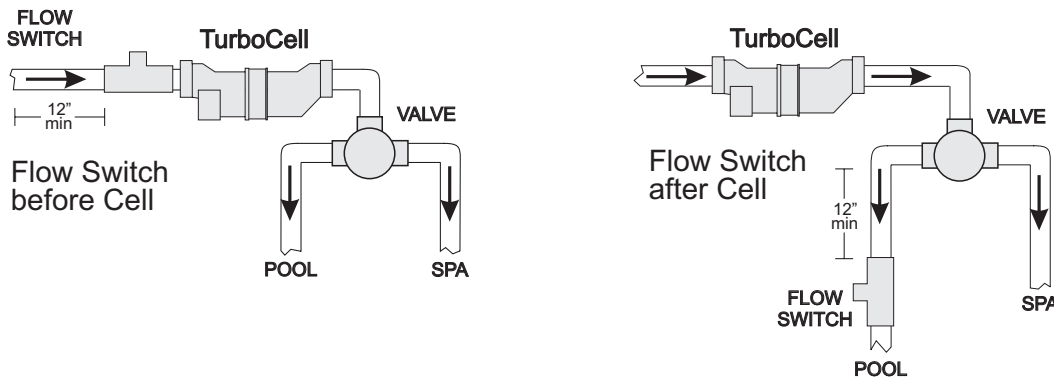

The cell may be mounted vertically or horizontally, and water can move in either direction through the cell. Install using the 2" unions provided. Tighten unions BY HAND for a watertight seal. For systems with 1½" plumbing use adapters (provided by installer).

Flow Switch (supplied with P-KIT)

A Hayward flow switch is required if using the optional TurboCell for chlorination, a liquid chlorine dispenser, chlorine tablet feeder or an AQL-CHEM2 for pH dispensing. The flow switch is a safety device that ensures that water is flowing before the OmniLogic/HLEXPAND starts to generate/dispense chlorine or dispenses acid. It must be plumbed in the same section of piping as the TurboCell or dispenser. Failure to properly install the flow switch can result in explosive gases or harsh chemicals accumulating in the pool plumbing system.

IMPORTANT: There must be at least a 12" (30cm) straight pipe run before (upstream) the flow switch. If the switch is plumbed after the cell, the cell can be counted as the 12" (30cm) of straight pipe.

IMPORTANT: To ensure proper operation, verify that the arrow on the flow switch points in the direction of water flow.

Electrical Wiring

The Expansion Panel requires both high and low voltage connections. Low voltage connections will be made to actuators, sensors, etc. High voltage connections will be made to pumps, lights, etc., as well as providing direct input power to the HLEXPAND. Always:

- Ensure that Power is disconnected prior to performing any wiring
- Follow all local and NEC (CEC if applicable) codes
- Use copper conductors only
- Remove power to the HLEXPAND subpanel before removing the deadfront

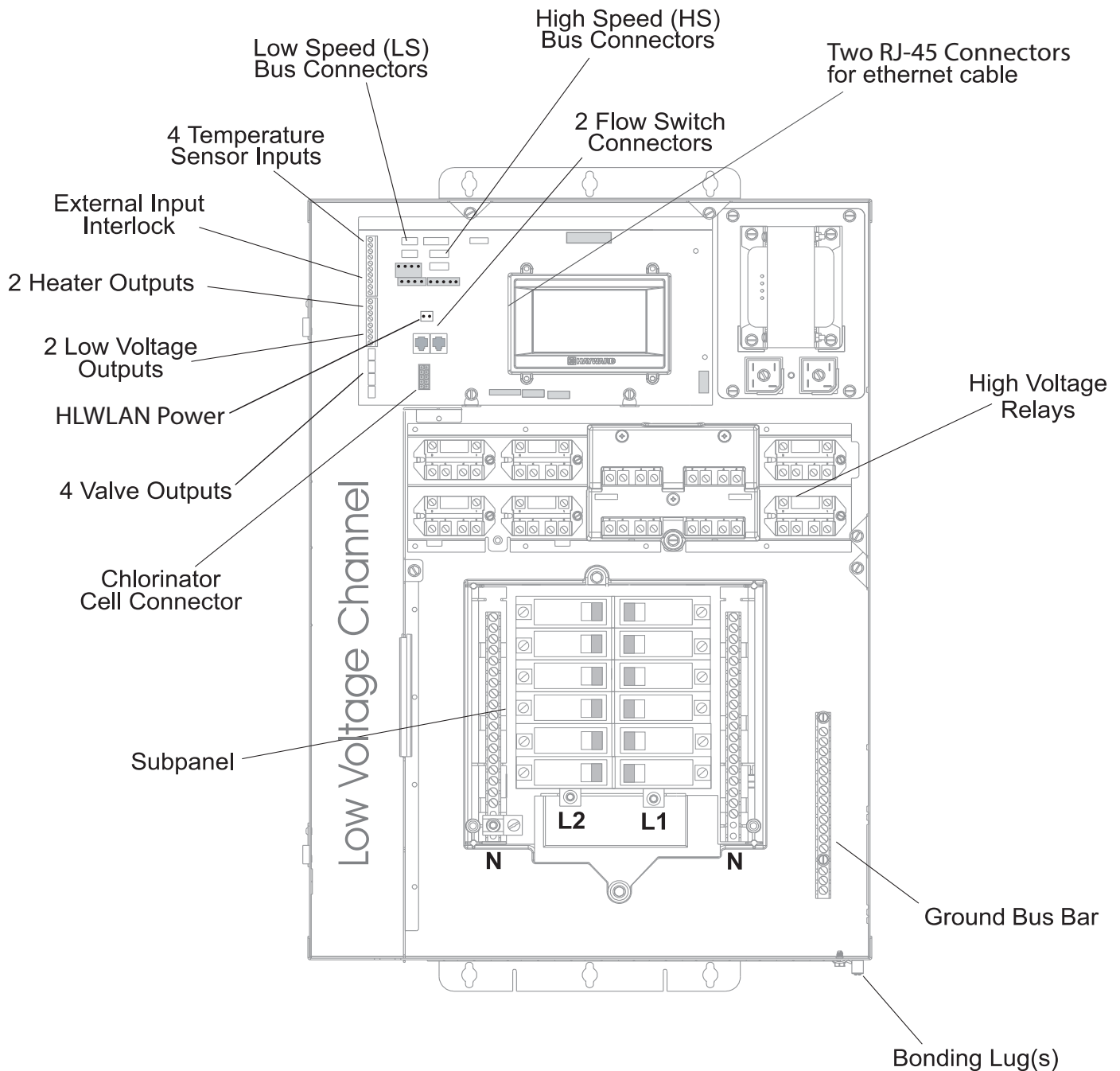



Main Service (Power to the Circuit Breaker Subpanel)

The HLEXPAND circuit breaker subpanel can accommodate up to 12 circuit breakers and is rated for 100A service. Run properly rated conductors (L1, L2, N, and ground) from the primary house electrical panel to the main power connections on the HLEXPAND circuit breaker base. The connection at the main house panel should be to a 240VAC circuit breaker rated at 125A maximum.

Grounding and Bonding

Connect a ground wire from the primary electrical panel to the HLEXPAND ground bus bar. Also ground each piece of high voltage (120 or 240VAC) equipment that is connected to the HLEXPAND control relays or circuit breakers. The HLEXPAND should also be connected to the pool bonding system by an 8AWG (6AWG for Canada) solid copper wire. A lug for bonding is provided on the outside/bottom of the enclosure.

Circuit Breaker Installation and Wiring

Circuit breakers are to be supplied by the installer. Refer to the circuit breaker chart below for a list of suitable circuit breakers that can be used. Follow the code and the circuit breaker manufacturer's rating requirements regarding the size and temperature rating for wiring. Note that some pool equipment may be required to be connected to ground fault circuit breakers—check local and NEC (CEC) codes.

SUITABLE LISTED BREAKERS							Tightening Torque
Manufacturer	Single	Double	Twin	Quad	GFCB	Filler Plates	
Eaton/ Cutler-Hammer	BR	BR	BRD	BRD	-	BRFP	25lb-in
	BR	BR	BRD	BRD	-	BRFP	25lb-in
Siemens	QP	QP	QT	QT	QPF	QF3	25lb-in
Square D	HOM	HOM	HOMT	HOMT	HOM-GFI	HOMFP	25lb-in

General Purpose Outlet

If desired, a duplex receptacle with weatherproof cover (supplied by installer) may be installed in the knockout on the lower right side of the HLEXPAND enclosure. Per code, use a GFCI type receptacle or a standard receptacle protected by a Ground Fault Circuit Breaker.

HLEXPAND Power

The HLEXPAND requires 120VAC, 5A power to operate the control logic circuits and the chlorinator. This power should be connected to a dedicated circuit breaker.

⚠ WARNING: 120VAC only (permanent damage will occur if connected to 240V)

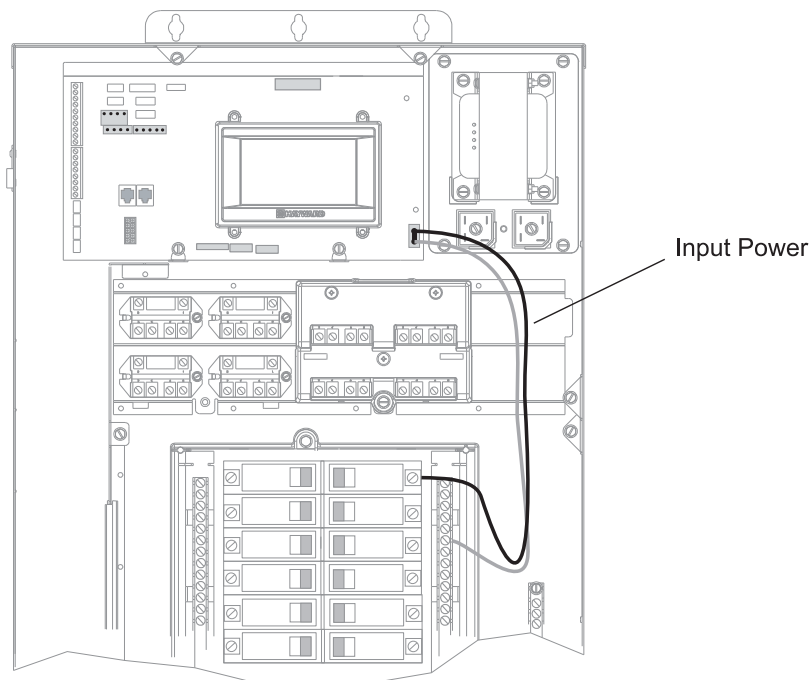

Connection Table

The HLEXPAND includes 4 high voltage relays, 4 low voltage/heater relays, 4 valve outputs and 4 temperature sensor inputs. Additional relays and inputs/outputs can be added using an HLRELAYBANK, HLIOEXPAND or HLRELAY(s) (see Accessories). When wiring pool equipment to the HLEXPAND, keep a record of all connections, just as you did with the HLBASE. To aid in this process, use the table below. To identify the various inputs/outputs, refer to the diagram on the side of the table. After attaching equipment to the HLEXPAND, fill in the appropriate information in the table.

Connection Table

Connection	Pool Equipment	Description
High Voltage Relays		
EPG0.MP.HVR1		
EPG0.MP.HVR2		
EPG0.MP.HVR3		
EPG0.MP.HVR4		
EPG0.RB.HVR5		
EPG0.RB.HVR6		
EPG0.RB.HVR7		
EPG0.RB.HVR8		
EPG0.MP.HVR9		
EPG0.MP.HVR10		

Low Voltage Relays/Heaters		
EPG0.MP.LVR1		
EPG0.MP.LVR2		
EPG0.MP.LVR3		
EPG0.MP.LVR4		
EPG0.IO Expander.LVR1		
EPG0.IO Expander.LVR2		
EPG0.IO Expander.LVR3		
EPG0.IO Expander.LVR4		

Valve Actuators		
EPG0.MP.VLV1		
EPG0.MP.VLV2		
EPG0.MP.VLV3		
EPG0.MP.VLV4		
EPG0.IO Expander.VLV1		
EPG0.IO Expander.VLV2		
EPG0.IO Expander.VLV3		
EPG0.IO Expander.VLV4		

Temperature Sensors		
EPG0.MP.SENS1 POOL		
EPG0.MP.SENS2 AIR		
EPG0.MP.SENS3 SOLAR		
EPG0.MP.SENSE4 EXT		
EPG0.MP.SENS5 DE SPA		
EPG0.IO Expander.SENS1		
EPG0.IO Expander.SENS2		
EPG0.IO Expander.SENS3		
EPG0.IO Expander.SENS4		

- When using Optional HLRELAYBANK
- When using Optional HLRELAY(s)
- When using Optional HLIOEXPAND

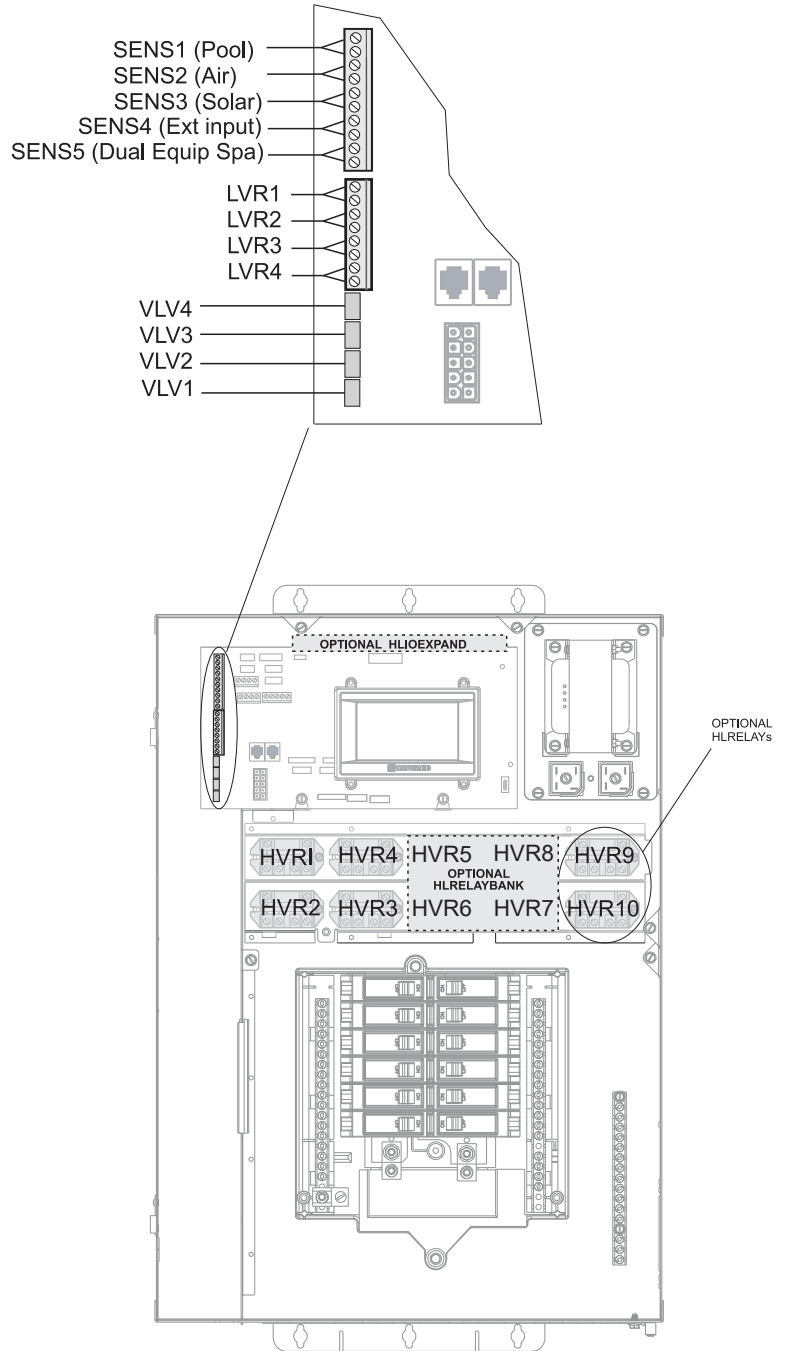

High Voltage Wiring

High Voltage Relays - (120/240V) Pool Equipment

All HLEXPAND relays are double pole (they make/break both "legs" of 240V circuits) and are rated at 3HP/30A at 25A at 240V and 25A at 120V. Refer to the diagram below for typical relay wiring. Record all connections using the table on page 8.

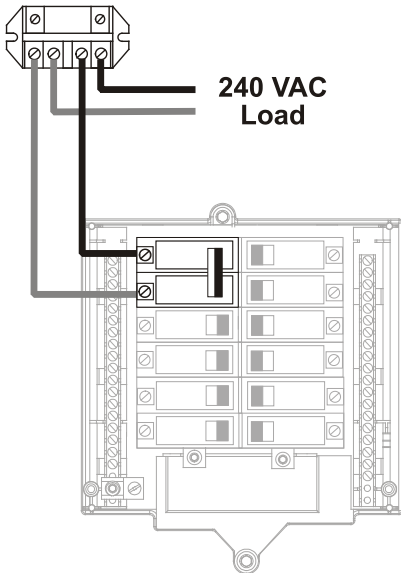

Wiring relays for 240 VAC Pool Equipment

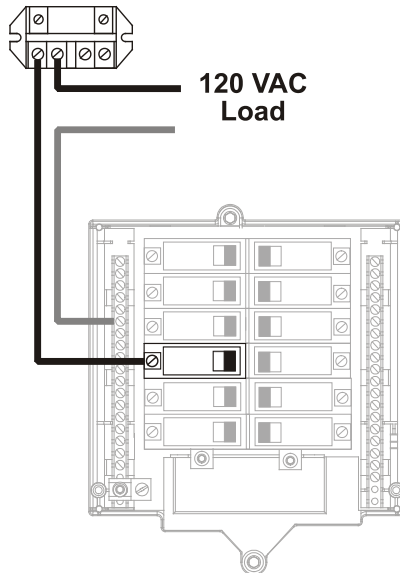

Wiring relays for 120 VAC Pool Equipment

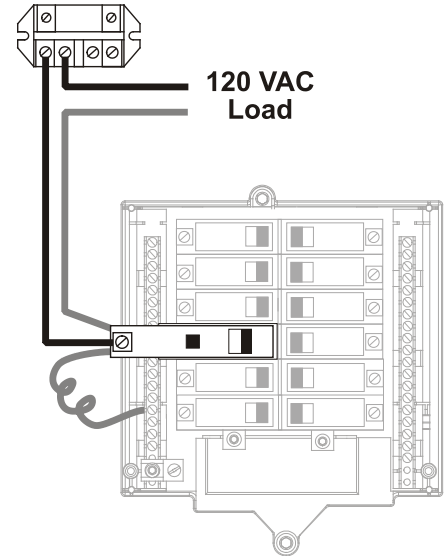

Wiring GFCB for 120 VAC Pool Equipment

⚠ WARNING: Do not use the HLEXPAND to control an automatic pool cover. Swimmers may become entrapped underneath the cover.

⚠ WARNING: Do not use the HLEXPAND to control fire pits or fire features.

Two speed filter pump

Requires two relays for proper operation of both speeds. NOTE: When selecting relays for two speed operation, both relays must be within the Relay Bank (HL-RELAYBANK) or neither relay should be within the Relay Bank. The diagram below shows the pump connected to relays *outside* of the Relay Bank.

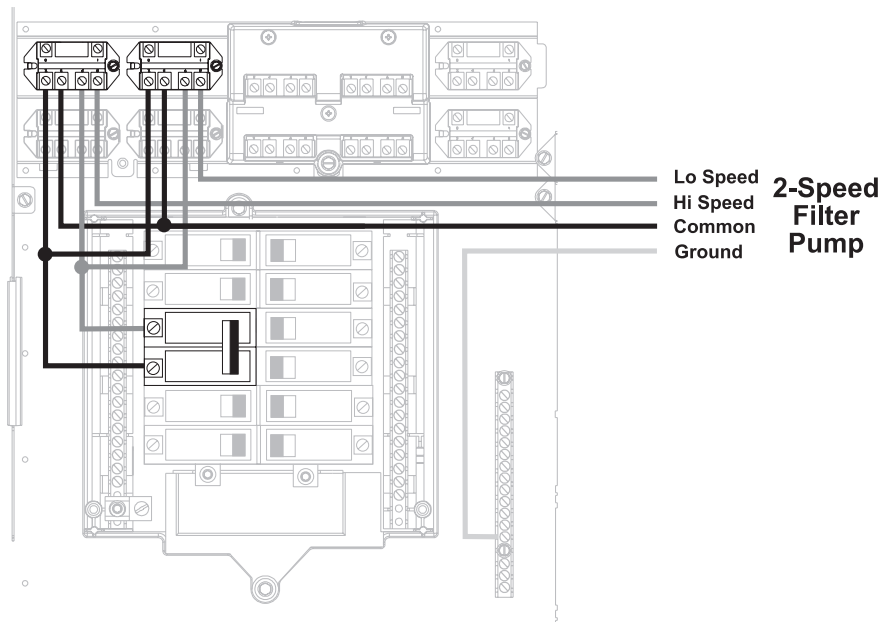



Lights

A ground fault circuit breaker (GFCB) must be used to supply power for high voltage pool/spa lighting. Low voltage lights will require an external transformer. For lighting systems that have both a light source and color wheel, connect the light source to one relay and then connect the color wheel to a different relay.

Universal ColorLogic Lights (UCL): Multiple UCLs must be wired to the same relay if synchronization is desired. Refer to your ColorLogic manual for more information.

Hayward Variable Speed Pump

Proper installation of a Hayward Variable Speed Pump (VSP) includes high voltage input wiring, low voltage communication wiring, and menu configuration/settings. The HLEXPAND can control up to 16 EcoStar VSPs without the use of a relay. Refer to the diagram below for proper 240VAC input wiring to the VSP. Refer to “Low Voltage Wiring” section in this manual for information on communication wiring. Refer to the VSP manual(s) for detailed wiring information.

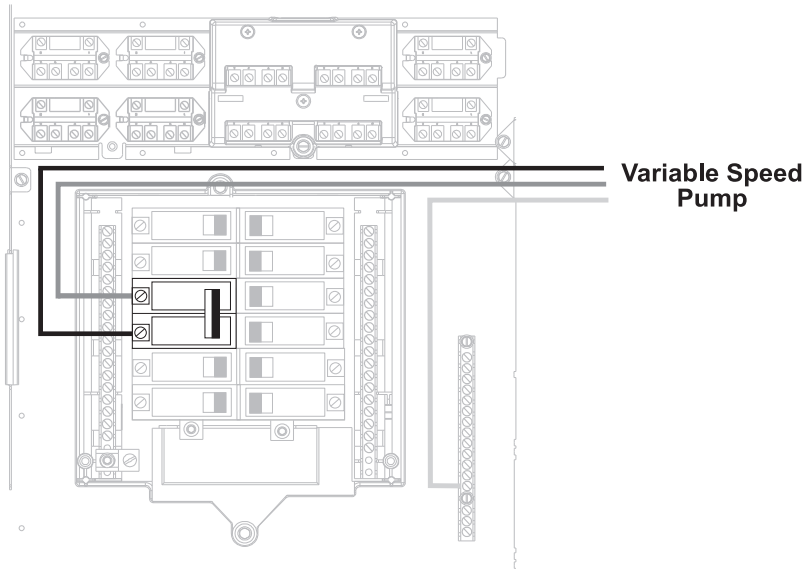

Cl and pH Dispense Output

Refer to the HL-CHEM owner's manual for detailed high voltage wiring instructions for chlorine and pH dispensing.

Low Voltage Wiring

Hayward Variable Speed Pump (VSP) Wiring

Hayward VSPs connect to the HLEXPAND in the same manner as the OmniLogic. Refer to your pump manual for proper low voltage communication wiring between the HLEXPAND and the Hayward VSP.

Valve Actuators

The HLEXPAND can control up to four automatic valve actuators. When used with the optional Input/Output Expander Board (HLIOEXPAND), up to 8 valve actuators can be used. Two of the valve outputs are normally used for the pool/spa suction (Valve2) and return (Valve1) valves. Valve3 and Valve4 are for general purpose use (solar, water feature, in-floor cleaner, etc.). All valve outputs on the HLIOEXPAND can be used in any manner.

For installations with solar heating, Hayward offers the AQ-SOL-KIT-xx solar kit that contains a valve, actuator, and extra temperature sensor. The “xx” indicates the valve type from the 2 choices below:

- 1P 1.5" Positive Seal
- 2P 2" Positive Seal

The OmniLogic is compatible with standard valve actuators manufactured by Hayward, Pentair/Compool, and Jandy. Actuators will connect to the VLV outputs on the Main Board. Refer to the diagram on page 8 for the location of valve connectors (VLV) on the OmniLogic Main Board. Record all connections in the Connection Table on page 8.

Heater Control

Like the OmniLogic, the HLEXPAND provides a set of 4 low voltage dry contact relays that can be connected to most gas heaters or heat pumps with 24V control circuits. When used with the optional Input/Output Expander Board (HLIOEXPAND), 8 dry contact relays are available. Refer to the diagram below for a generic heater connection. The manuals supplied with most heaters also include specific wiring instructions for connecting the heater to an external control (usually identified as “2-wire” remote control). For millivolt or line voltage heaters, contact Hayward Tech support, 908-355-7995. Refer to the information on the following pages for more details on the connection to several popular heaters. Refer to the diagram on page 8 for the location of heater connections (LVR) on the HLEXPAND Main Board. Record all connections in the Connection Table.

Generic Heaters

1. Wire heater to 120/240V power source per the instructions in the heater manual. The OmniLogic does NOT control the power going to the heater.
2. Wire the dry contact heater output per the diagram below. Many internal parts of the heater can get very hot--see the heater manufacturer's recommendations on the minimum temperature rating for wires. If no guidance is given, use 105°C rated wire.
3. Set any ON/OFF switch on the heater to ON.
4. Set the thermostat(s) on the heater to the maximum (hottest) setting.

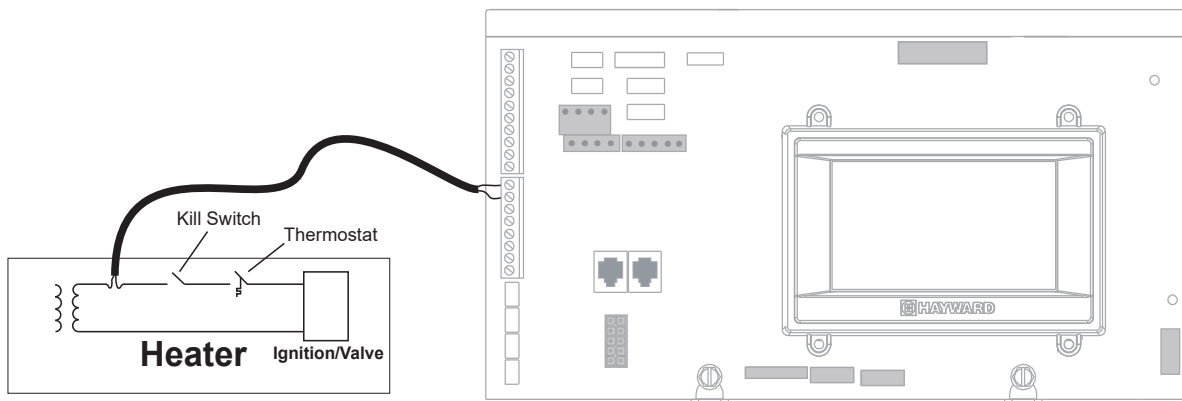

Hayward Pre-2007 Heaters

Refer to the instructions in the heater manual for “2-wire Remote Thermostat” operation under “Remote Control Connections” and the diagram below:

1. Turn off power to heater.
2. Wire HLEXPAND to terminals 1 & 2 (see diagram).
3. Leave jumper attached to terminals 4 & 5.
4. Move “BYPASS” dipswitch on heater circuit board to “ON” position (up).
5. Turn heater power back on.
6. Switch heater to either “Pool” or “Spa” (it doesn't make any difference which is selected, the OmniLogic will take control).
7. Heater display should be “bO” (for “bypass On”).

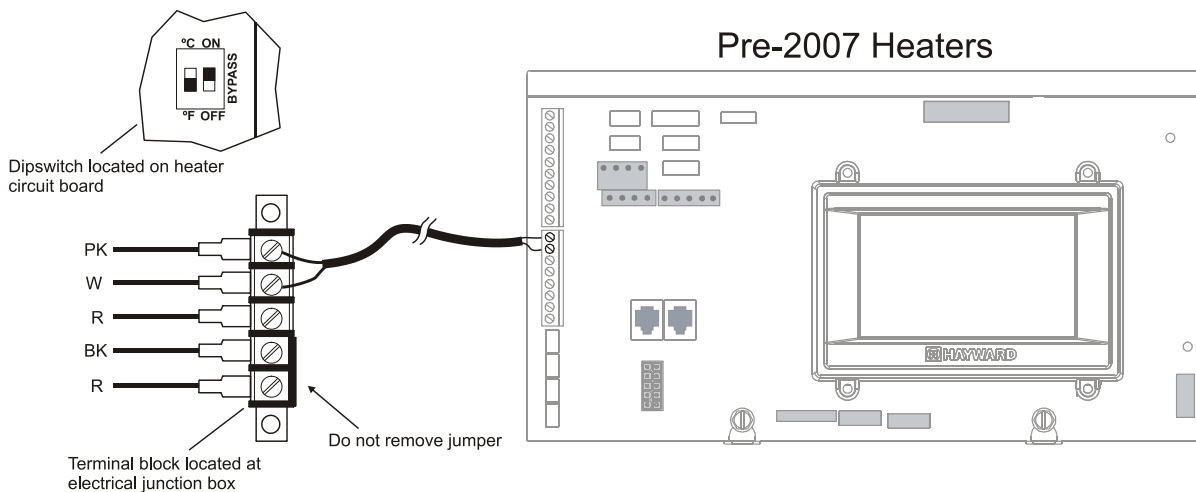

Hayward 2007-Current Heaters

Refer to the instructions in the heater manual for "2-wire Remote Thermostat" operation under "Remote Control Connections" and the diagram below:

1. Turn off power to heater.
2. Wire HLEXPAND to the heater terminals that have the Orange & White connections (see diagram).
3. Turn heater power back on.
4. Use the "MODE" key on the heater keypad to put the control into "STANDBY" mode.
5. Press and hold both the "DOWN" and "MODE" keys for 3 seconds until the display shows the code "bo".
6. Be sure to put the heater's control in either "POOL" or "SPA" mode.
7. The HLEXPAND will now control the heater.

To configure the heater for 2-wire remote thermostat control, use the "MODE" key on the heater keypad to put the control into "STANDBY" mode. Then press and hold both the "DOWN" and "MODE" keys for 3 seconds until the display shows the code "bo".

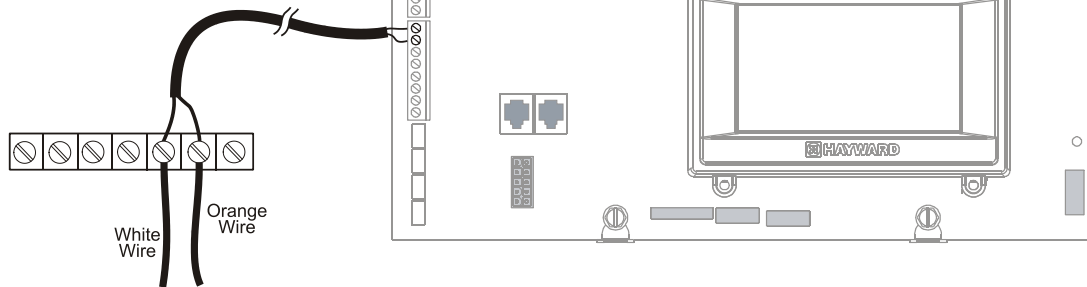

2007- Current Heaters

Temperature Sensors

The HLEXPAND utilizes 10K ohm thermistor type sensors and provides four inputs. If the HLEXPAND is being used to control a solar heating system, the solar sensor is required. If dual equipment will be used, the dual equipment spa sensor is required. If both solar and dual equipment are desired, another temperature sensor must be purchased separately. The sensors are provided with a 15 ft. cable. If a longer cable is required, contact the Hayward service dept. (908-355-7995) for information on suitable cable types and splices. Wire sensors as shown below. Record all connections using the table on page 8.

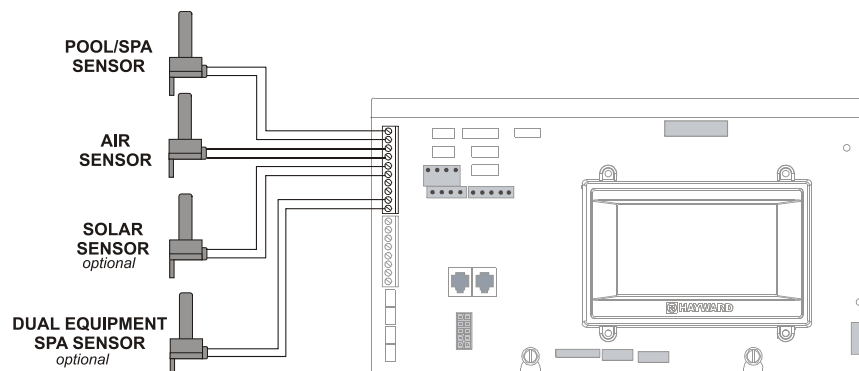

External Input Interlock

Like the OmniLogic's External Input Interlock, the HLEXPAND's input provides a means to turn the filter pump or other component on/off when certain conditions exist. A normally open or normally closed on/off external device must be connected to the HLEXPAND as shown below. After properly configuring the OmniLogic (see Configuration Wizard in the HLBASE Installation Manual), the filter pump and/or desired pool component will be forced on or off when the device is active. Record all connections using the table on page 8.

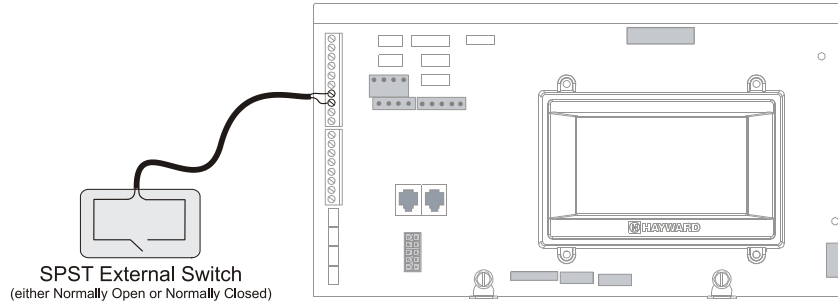

HL-CHEM ORP and pH Sensing Kit

Plug in the connector from the HL-CHEM into one of the Low Speed Bus connectors on the HLEXPAND'S Main Board as shown below. Refer to the HL-CHEM manual for complete installation instructions.

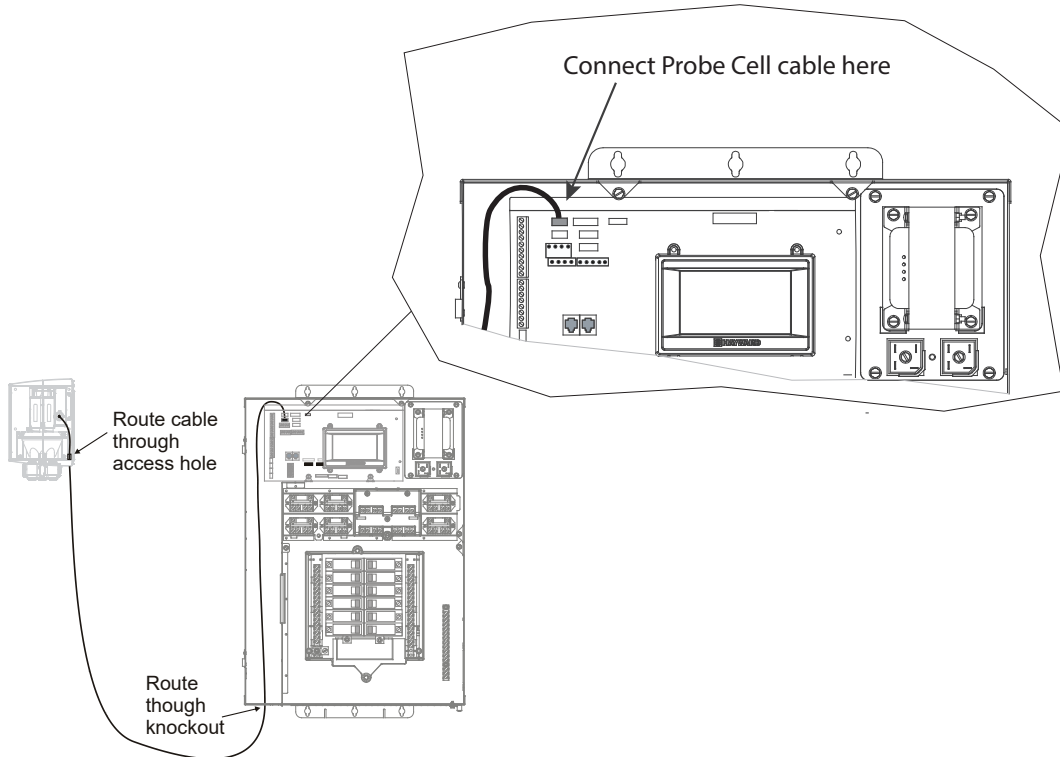

Ethernet Connections

Connect the supplied 15 ft. Ethernet cable from the HLEXPAND to the OmniLogic.

If web enabled devices such as a PC, laptop, tablet or phone will be used to access the OmniLogic, an Ethernet connection must also be made to the home router. Use outdoor rated Cat5e or Cat6 Ethernet cable. Connect one end to the HLEXPAND and the other to an available LAN port (not WAN) on the home router. If running Ethernet cable between the HLEXPAND and home router is impractical, a Hayward HLWLAN can make a wireless connection to the home router instead (see below). Connect the PoE injector power cable to the “HLWLAN Power” connector on the PCB (see page 6 for location) after running through the ferrite bead supplied with the HLEXPAND. Note that the HLWLAN can be powered from either the HLBASE or the HLEXPAND PCB.

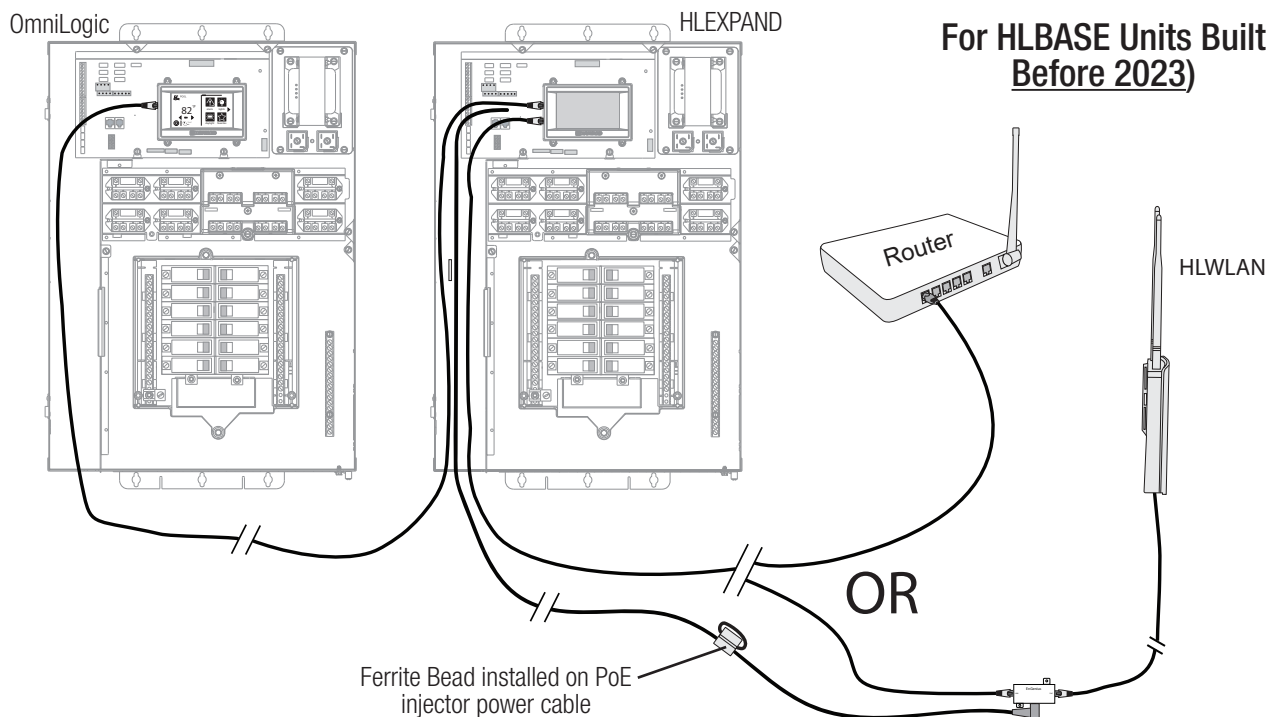
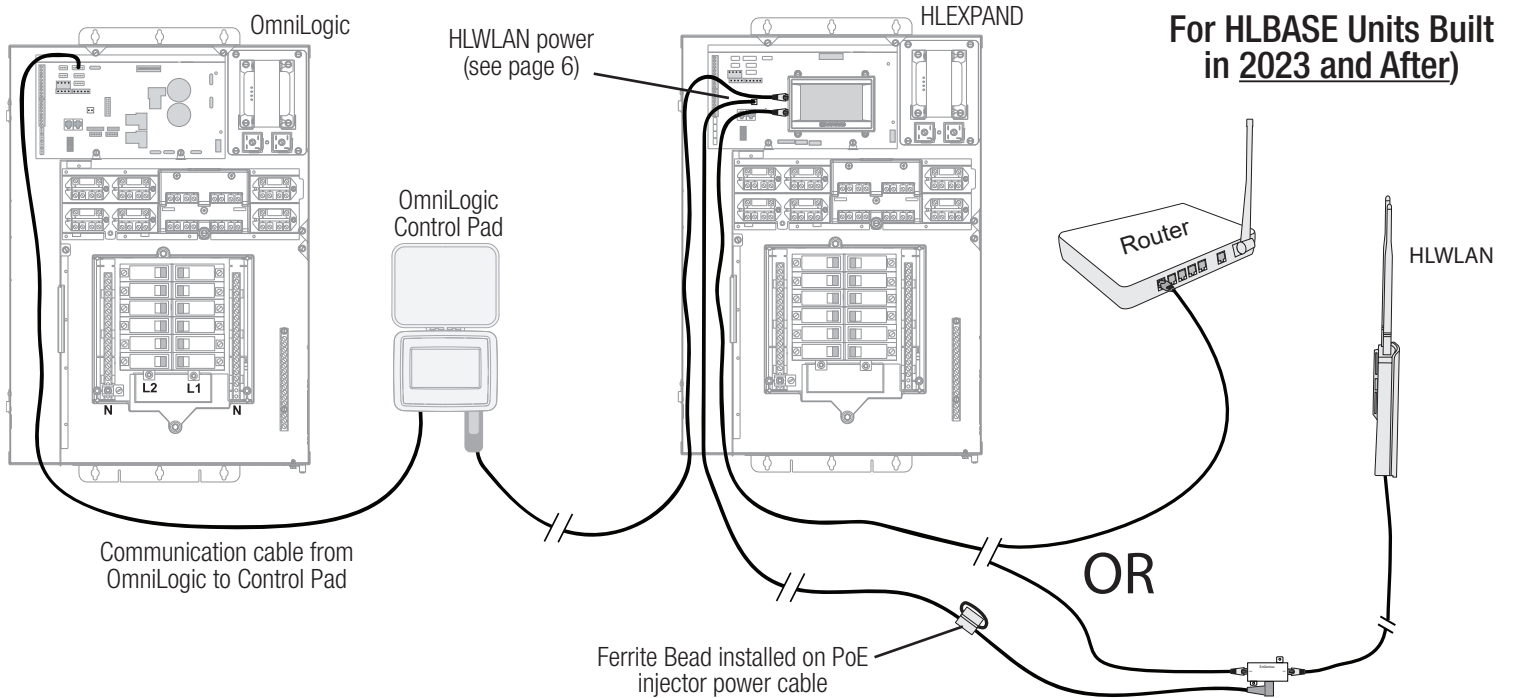



Flow Switch

The flow switch cable plugs into the flow switch connector on the Main Board as shown on page 6. Ensure that the connector catch “snaps” in order to provide a reliable connection.

TurboCell

Only applicable if the chlorinator function is enabled for an additional body of water. The TurboCell should be plugged in AFTER the HLEXPAND deadfront panel is installed. Refer to page 6 for the location of the chlorinator cell connector.

HLIOEXPAND

The HLIOEXPAND is design to slide between guide rails and insert into a dedicated slot on the HLEXPAND Main Board. At startup, the HLEXPAND will discover the HLIOEXPAND and its inputs/outputs can be configured within the OmniLogic’s Configuration Wizard. Refer to the HLIOEXPANDER manual for specific installation instructions.

HLRELAYBANK

Offering four additional high voltage relays, the HLRELAYBANK is a relay kit accessory designed to install next to the four onboard relays in the HLEXPAND (see page 8). After installing the HLRELAYBANK, a wire connection must be made at the HLEXPAND Main Board. At startup, the OmniLogic will detect the HLEXPAND’s HLRELAYBANK and allow the user to configure the additional relays in the Configuration Wizard. Refer to the HLRELAYBANK manual for installation instructions.

HLRELAY

The HLRELAY is a single high voltage relay designed to be mounted in the #9 and/or #10 positions (page 8). After installing the HLRELAY, a wire connection must be made at the HLEXPAND Main Board. At startup, the OmniLogic will detect the HLRELAY and allow the user to configure the additional relay(s) in the Configuration Wizard. Refer to the HLRELAY manual for installation instructions.

HLWLAN

The HLWLAN can be mounted up to 25 ft. away from the HLEXPAND and requires an Ethernet connection to the HLEXPAND as well as a power connection to the HLEXPAND Main Board. Refer to the HLWLAN manual for detailed installation instructions.

System Startup

Before powering up the HLEXPAND, check the following and then replace the deadfront panel:

- Properly rated circuit breakers are installed in the HLEXPAND subpanel.
- All wiring is performed according to NEC and local codes.
- The HLEXPAND is properly grounded and bonded.

NOTE: The OmniLogic deletes programmed Themes when new hardware is discovered. If the OmniLogic has already been in service before adding the HLEXPAND, any programmed Themes will be lost at startup. You'll need to reprogram Themes after configuring the OmniLogic for use with the HLEXPAND.

Power up the OmniLogic HLBASE and HLEXPAND. At the local terminal, confirm that the OmniLogic has discovered the HLEXPAND in "System Info" as shown below:

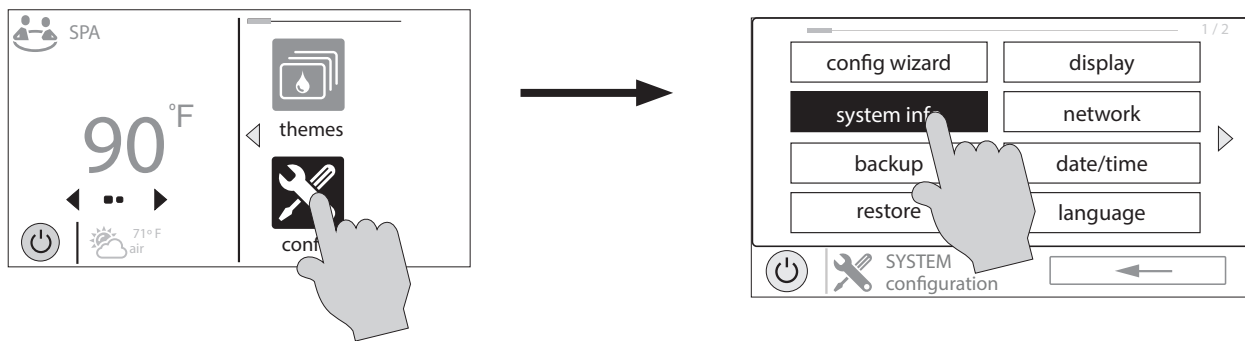

"EPGxxx" entries confirm that the OmniLogic is communicating with the Expansion Panel. If these entries are not found, review your installation for errors starting at the beginning.

msp id:3233

component	HUA	version
EPGOMP	01-46-01-12-75	R.2.3.0
EPGORB	01-46-01-80-26	R.2.3.0
Relays	3-10-0-0-1	R.1.0.4
EcoStar pump	10-0-0-0-4e	R.3.0.4
EcoStar pump	10-0-0-0-54	R.3.0.4

SYSTEM INFO

Firmware Upgrade

After communication is confirmed, the firmware on both units should be updated (even if the OmniLogic has been in service). Firmware is the basic operating system and both the OmniLogic and HLEXPAND were shipped with versions of firmware that were available at the time of release. There may be a newer version available and if so, we encourage you to upgrade. Also, if you have experienced problems, Hayward Technical Support may advise you to upgrade your firmware.

The procedure for upgrading firmware when using an HLEXPAND is to upgrade the OmniLogic first, then upgrade the HLEXPAND. Any wired or wireless remote controls should also be upgraded. For instructions on how to upgrade firmware, refer to the procedure shown in the OmniLogic Operation Manual.



Configuration

The HLEXPAND can now be configured. Refer to the OmniLogic Installation manual for configuration information. If the OmniLogic has been in service before the HLEXPAND has been installed, you can edit the existing OmniLogic configuration. For new installations where the OmniLogic and HLEXPAND have been installed together, run the Configuration Wizard. Both methods are explained in the OmniLogic's Installation manual.

When assigning equipment to relay and valve outputs or selecting sensors and external switches, prefixes are given to help identify the location of each. Refer to the information below.

MP - inputs and outputs included in the HLBASE OmniLogic

RB - additional high voltage relays when an optional HLRELAYBANK has been installed in an OmniLogic

IO EXPANDER - additional low voltage relays and sensor/ext switch inputs when an optional IOEXPANDER has been installed in an OmniLogic

EPGO.MP - inputs and outputs included in the HLEXPAND Expansion Panel

EPGO.RB - additional high voltage relays when an optional HLRELAYBANK has been installed in an HLEXPAND

EPGO.IO EXPANDER - additional low voltage relays and sensor/ext switch inputs when an optional IOEXPANDER has been installed in an HLEXPAND

After configuration, refer to the OmniLogic Operation manual for Operation instructions. Test that all pool equipment is operating properly.

Create and/or login to your account at www.haywardomnilogic.com and confirm that you can remotely control all of your equipment. Your installation is now complete.





HAYWARD®

LIMITED WARRANTY (effective 03/01/12) Hayward warrants its OmniLogic, Pro Logic, OnCommand and E-Command pool automation products as well as its Aqua Rite, Aqua Rite Pro, Aqua Plus and SwimPure chlorination products to be free of defects in materials and workmanship, under normal use and service, for a period of three (3) years. Hayward also warrants its Aqua Trol chlorination products to be free of defects in materials and workmanship, under normal use and service for a period of one (1) year. These warranties are applicable from the initial date of purchase on private residential swimming pools in the US and Canada. Installations of product for use on commercial pools in the US and Canada is covered for a period of one (1) year for defects in materials and workmanship. Hayward warrants all accessories and replacement parts for the above-identified pool automation and chlorination products for a period of one (1) year. Accessories also include remotes, actuators, base stations, temperature sensors, flow switches and chemistry probes. Each of these warranties is not transferable and applies only to the original owner.

Hayward shall not be responsible for cartage, removal, repair or installation labor or any other such costs incurred in obtaining warranty replacements or repair.

Proof of purchase is required for warranty service. If written proof of purchase is not provided, the manufacturing date code will be the sole determinant of the date of installation of the product. To obtain warranty service or repair, please contact the place of purchase or the nearest Hayward authorized warranty service center. For more information on authorized service centers please contact the Hayward Technical Service Support Center (61 Whitecap Road, North Kingstown RI, 02852) or visit the Hayward web site at www.hayward.com.

WARRANTY EXCLUSIONS:

1. Material supplied or workmanship performed by others in process of installation.
2. Damage resulting from improper installation including installation on pools larger than the product rating.
3. Problems resulting from failure to install, operate or maintain the product(s) in accordance with the recommendations contained in the owners manual(s).
4. Problems resulting from failure to maintain pool water chemistry in accordance with the recommendations in the owners manual(s).
5. Problems resulting from tampering, accident, abuse, negligence, unauthorized repairs or alterations, fire, flood, lightning, freezing, external water, degradation of natural stone used in or immediately adjacent to a pool or spa, war or acts of God.
6. Use of a non-genuine Hayward replacement salt chlorination cell on any Hayward automation or chlorination product will void the warranty for that product.

The express limited warranty above constitutes the entire warranty of Hayward Pool Products with respect to its products and is in lieu of all other warranties expressed or implied, including warranties of merchantability or fitness for a particular purpose. In no event shall Hayward Pool products be responsible for any consequential, special or incidental damages of any nature. Some states do not allow a limitation on how long an implied warranty lasts, or the exclusion of incidental or consequential damages, so the above limitation may not apply to you. This warranty gives you specific legal rights, and you may also have other rights, which vary from state to state.

FOR FURTHER INFORMATION OR CONSUMER
TECHNICAL SUPPORT, VISIT OUR WEBSITE AT
www.hayward.com



Hayward is a registered trademark and OmniLogic is a trademark of Hayward Industries, Inc. © 2024 Hayward Industries, Inc.

All other trademarks not owned by Hayward are the property of their respective owners. Hayward is not in any way affiliated with or endorsed by those third parties. For patent information, refer to www.hayward.com/patents.